

MET

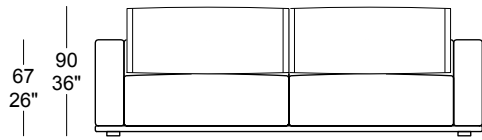

MET 01

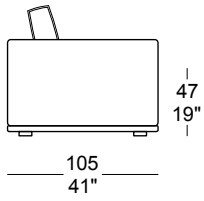
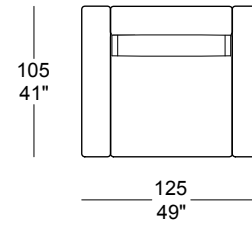

MET 02

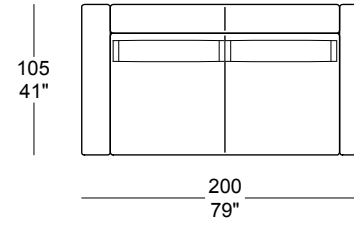

MET 03

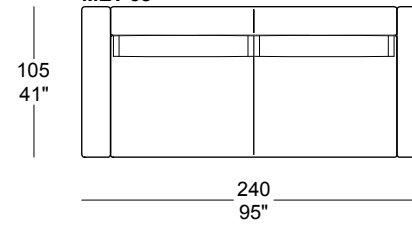

MET 04

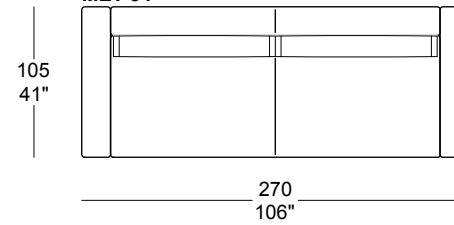

MET

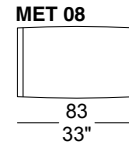
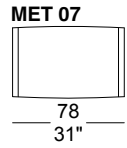
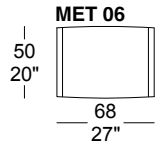
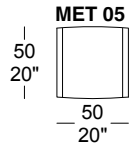

2 ▶

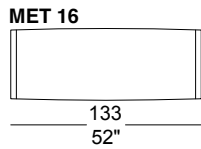
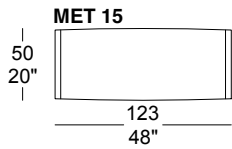
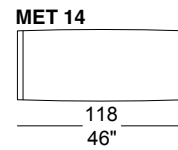
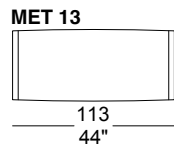
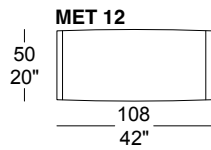
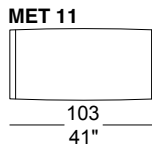
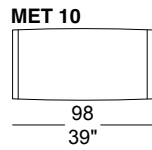
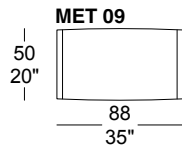

MET

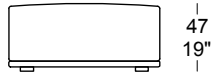

47
19"

MET 22

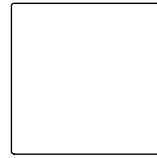

105
41"

105
41"

MET 23

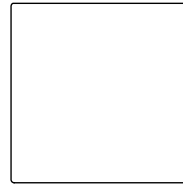

125
49"

125
49"

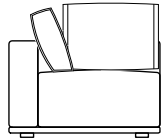

47
19"

67
26"

90
35"

105
41"

MET 24

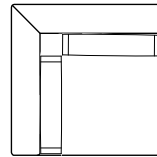

105
41"

105
41"

MET

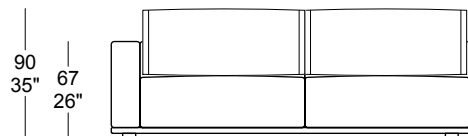
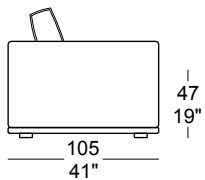

MET 25

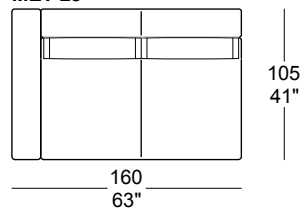

MET 29

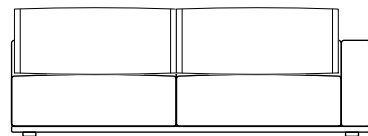
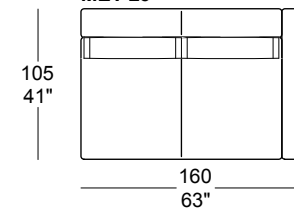

MET 26

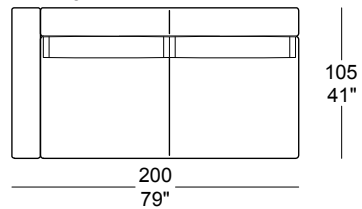

MET 30

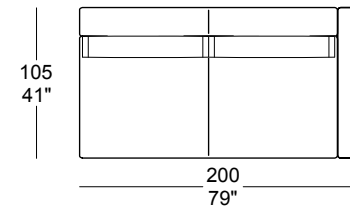

4 ▶

MET 27

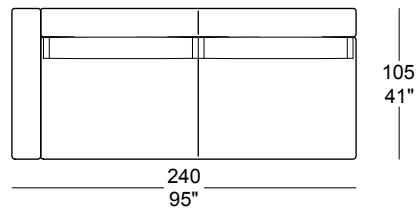

MET 31

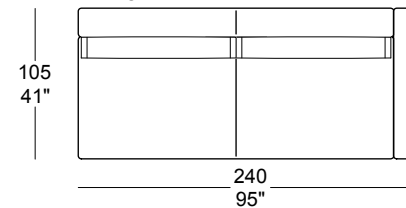

MET 28

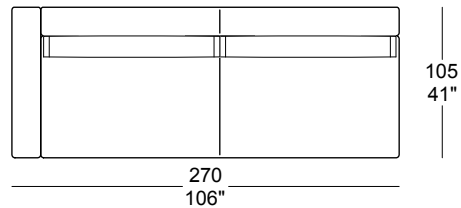

MET 32

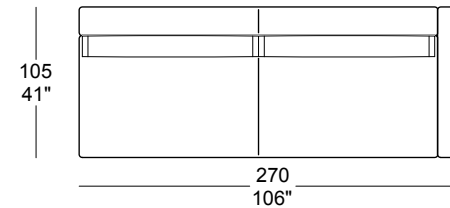

MET

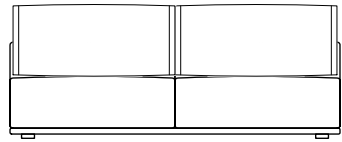
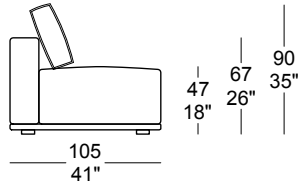

5 ▶

MET 33

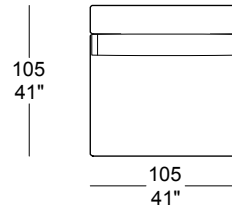

MET 34

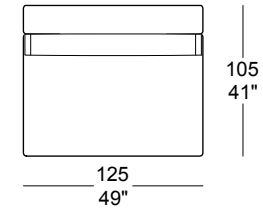

MET 35

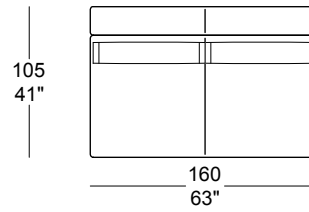

MET 36

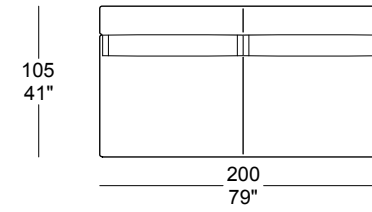

MET 37

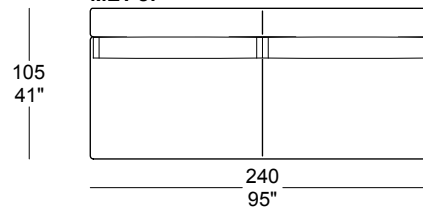

MET 38

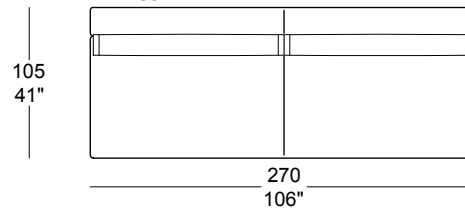

MET

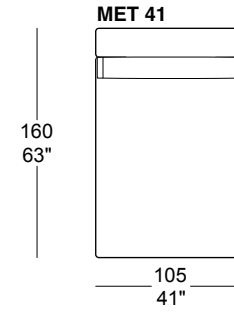
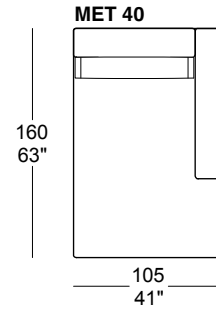
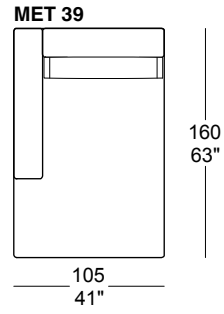
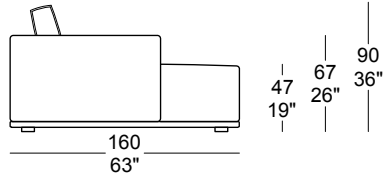

6 ▶

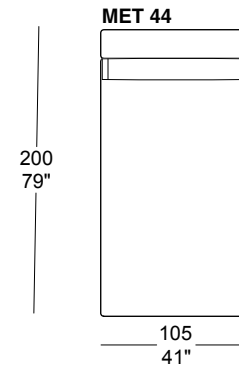
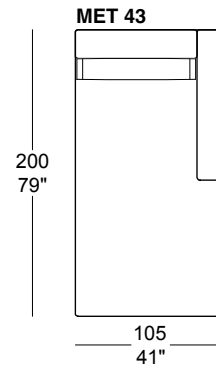
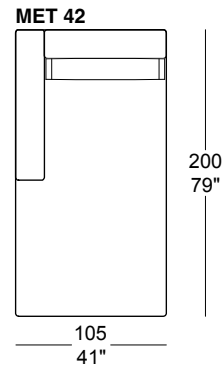
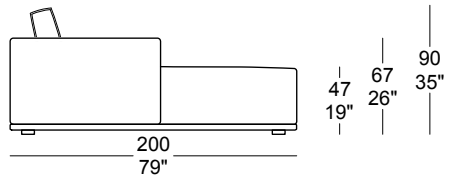

MET

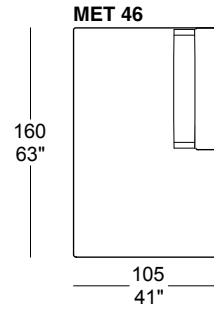
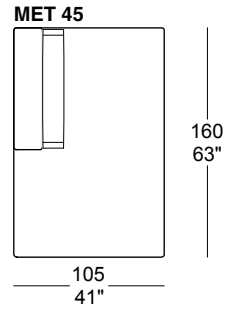
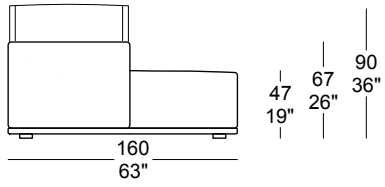

7 ▶

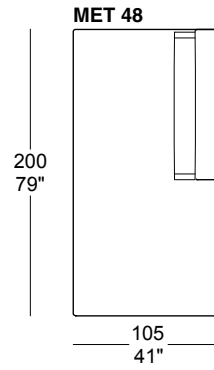
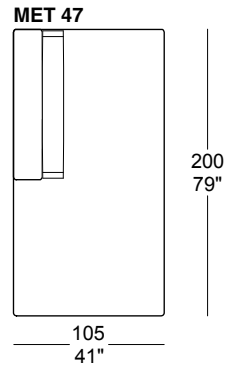
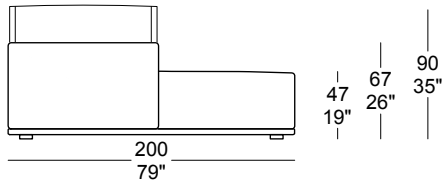

MET

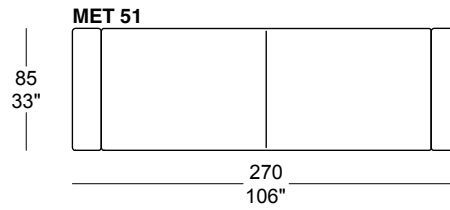
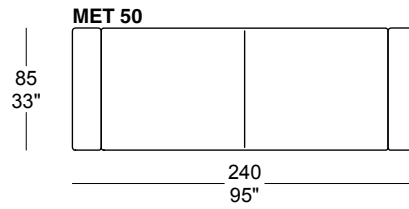
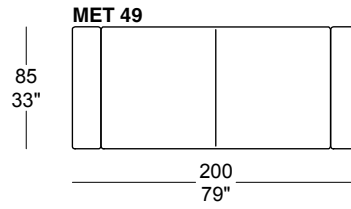
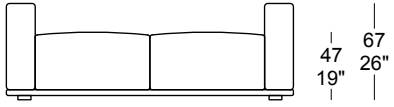

MET

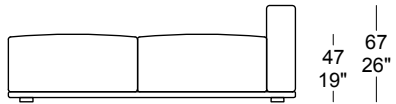
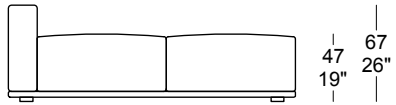

9 ▶

MET 52

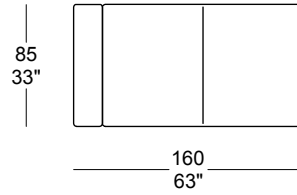

MET 56

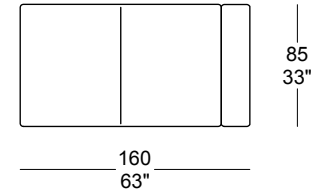

MET 53

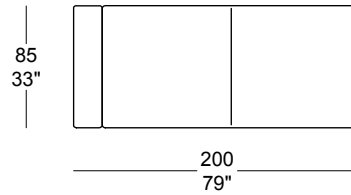

MET 57

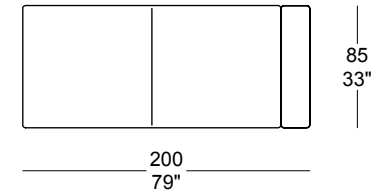

MET 54

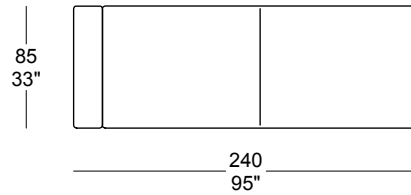

MET 58

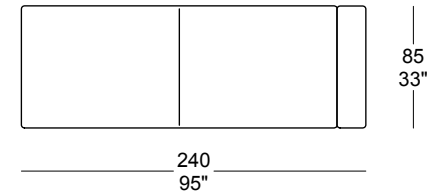

MET 55

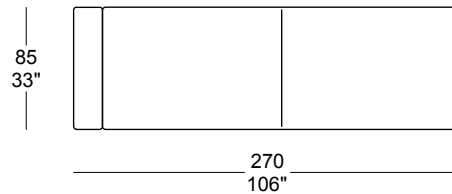

MET 59

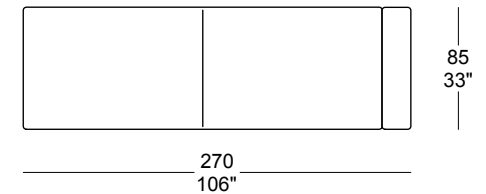

MET

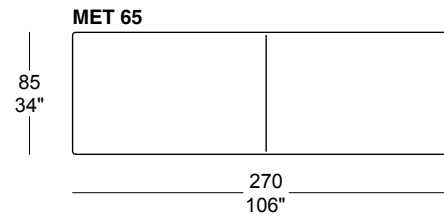
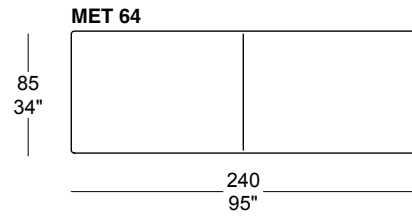
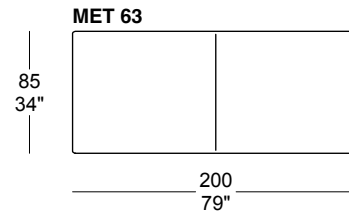
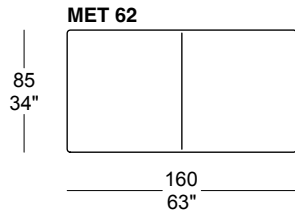
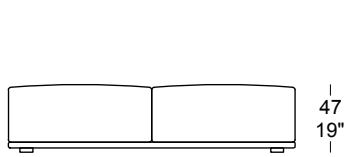
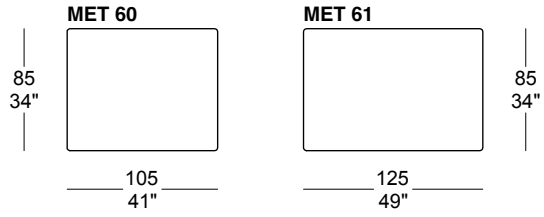

MET

MET 66

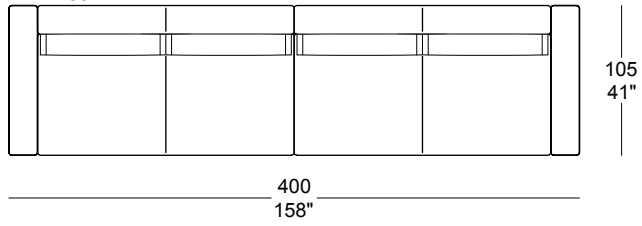

MET 67

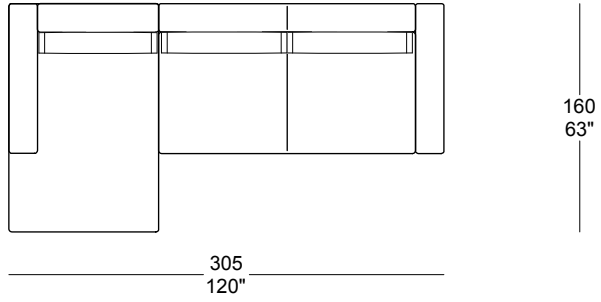

MET 68

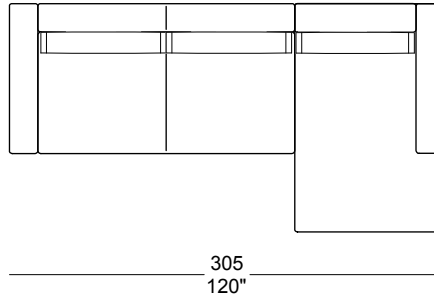

MET 69

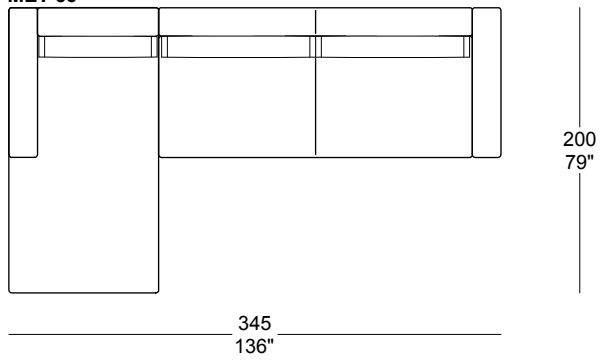

MET 70

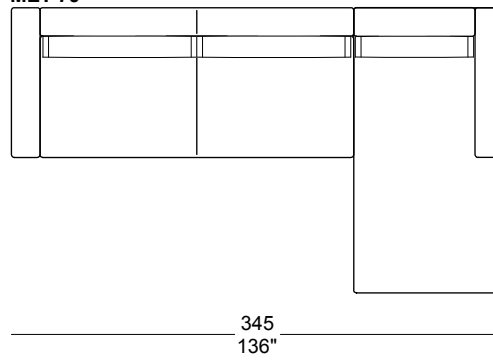

MET

MET 71

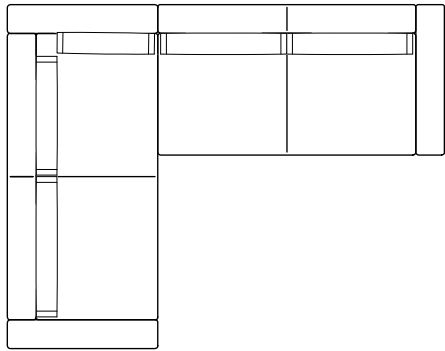

305
120"

240
95"

MET 72

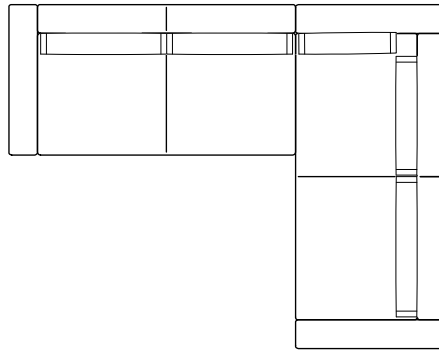

305
120"

12 ▶

MET 73

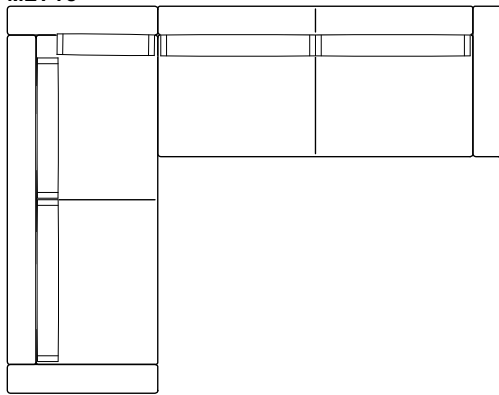

345
136"

270
106"

MET 74

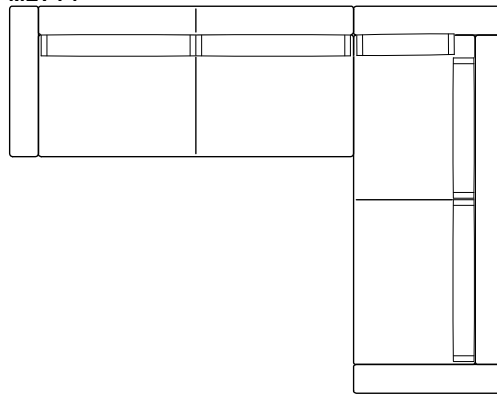

345
136"

MET

MET 75

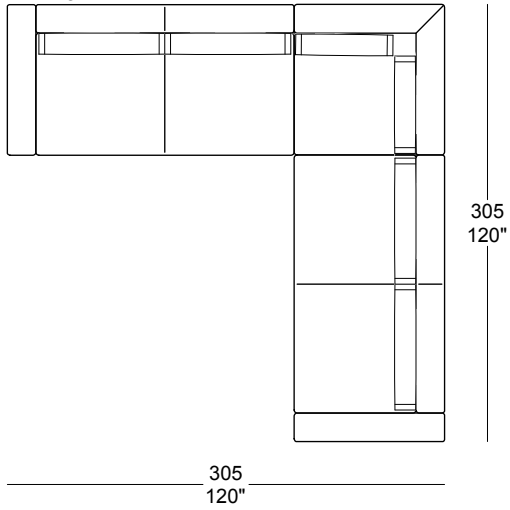

MET 76

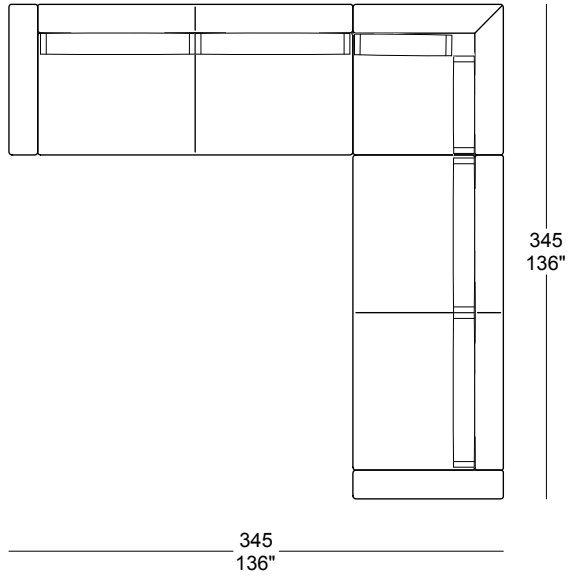

MET 77

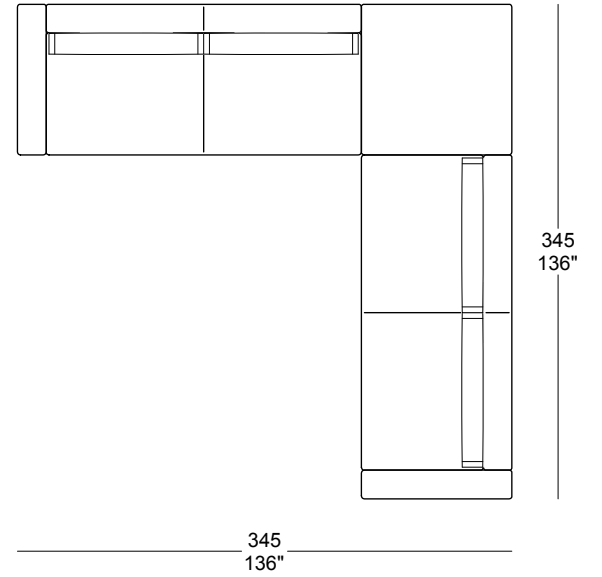

13 ▶

MET 78

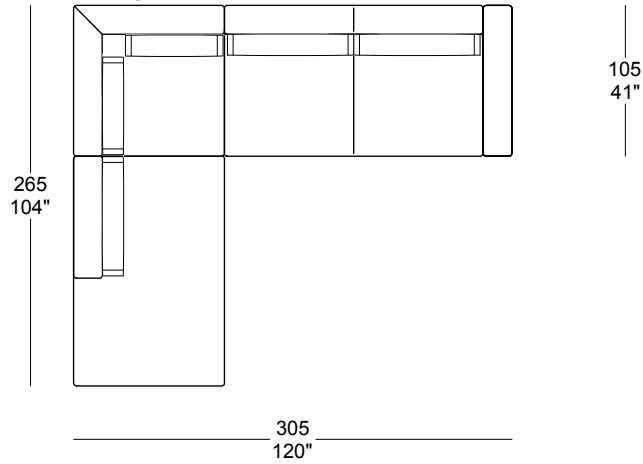

MET 79

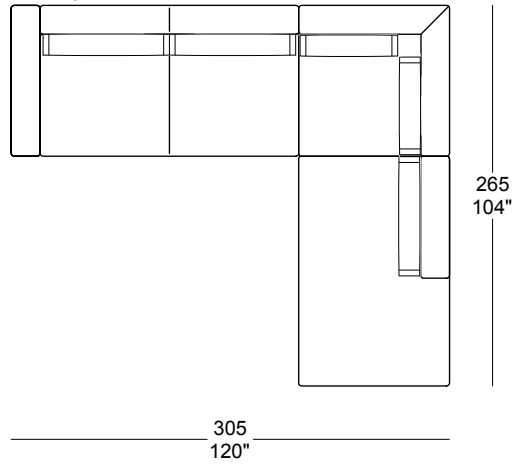

MET

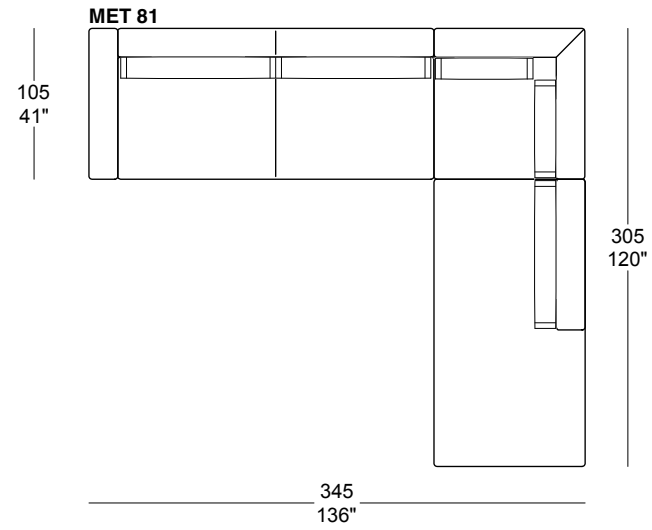
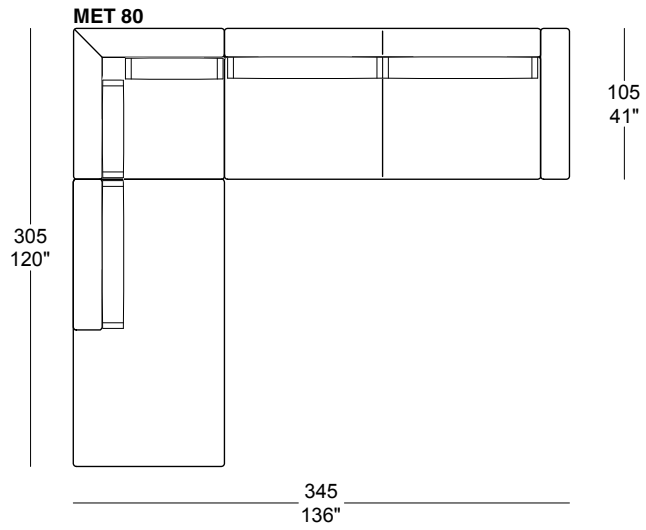

14 ►

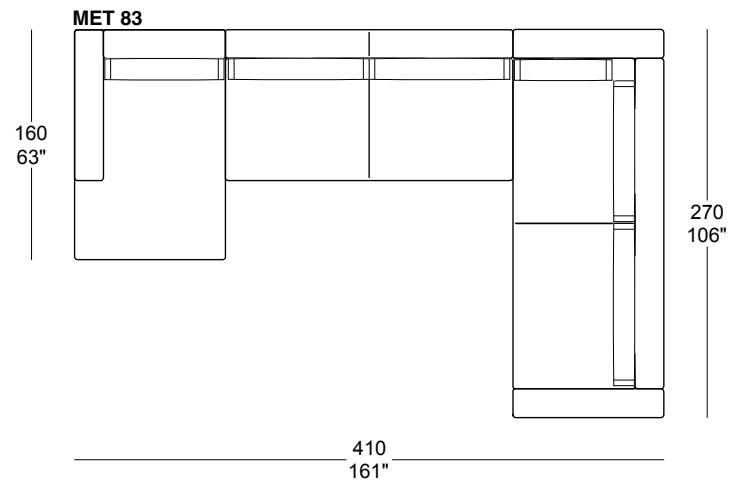
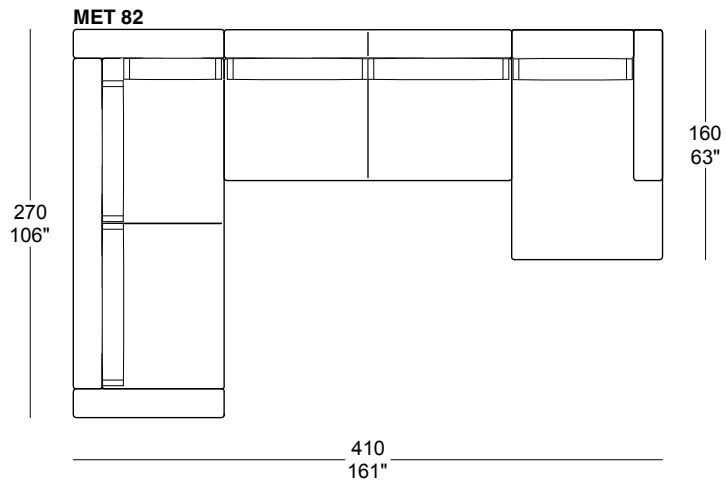

MET

MET 84

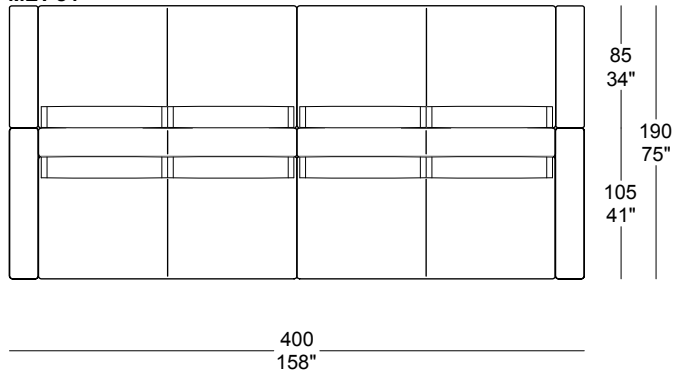

15 ►

MET 85

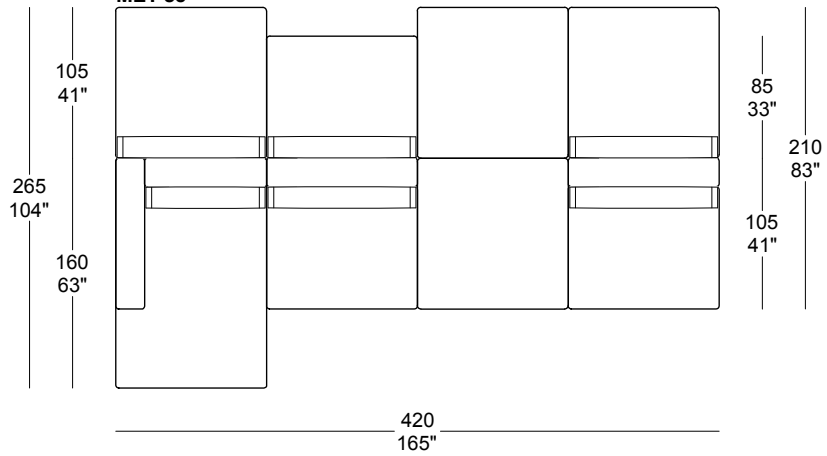

MET 86

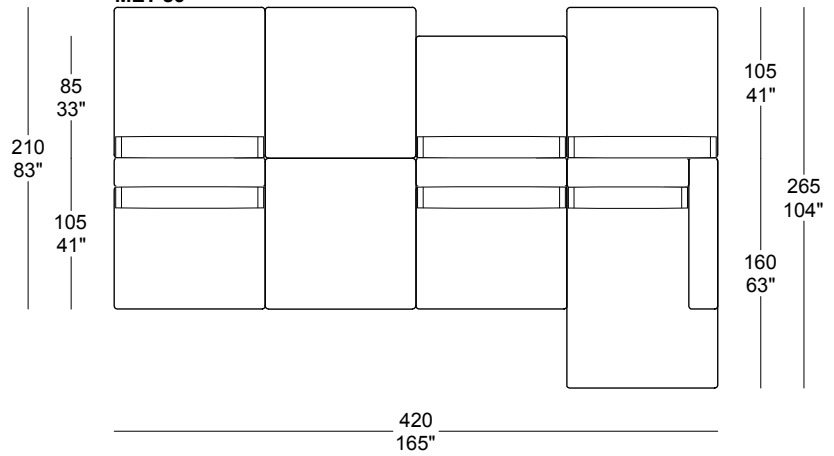

MET

MET 87

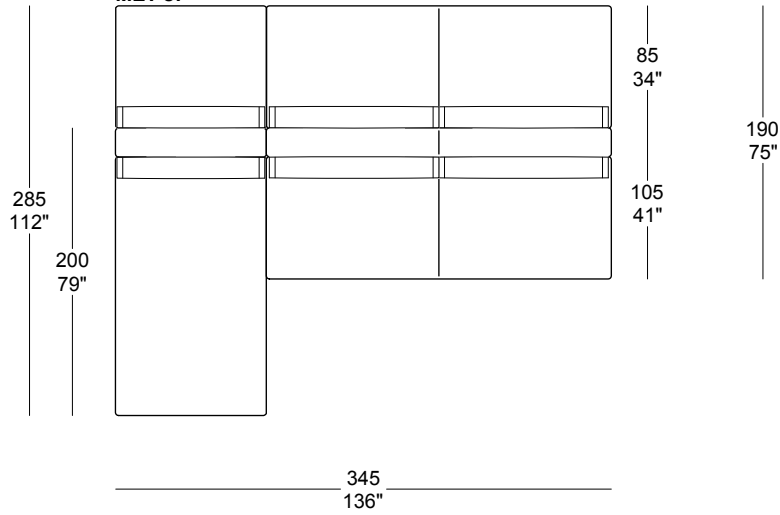

MET 88

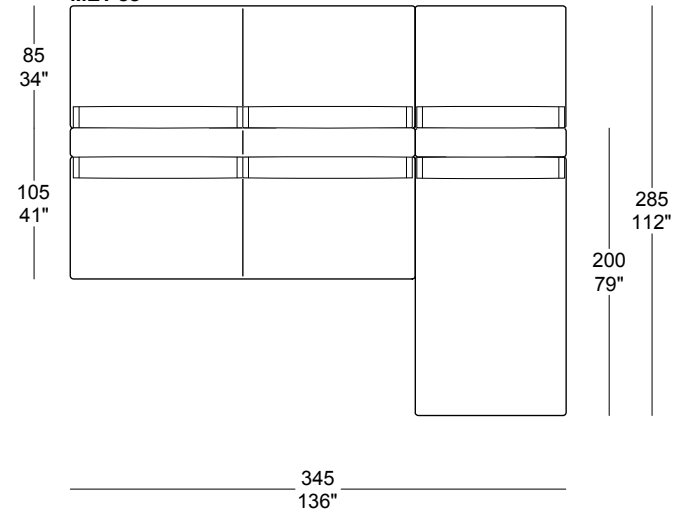

16 ►

MET 89

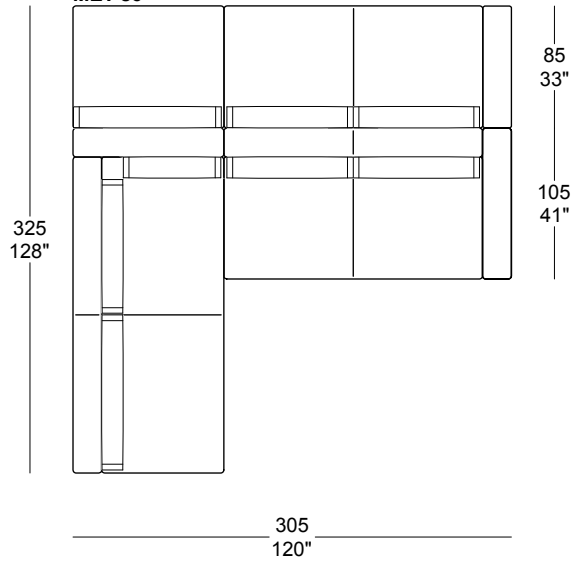

MET 90

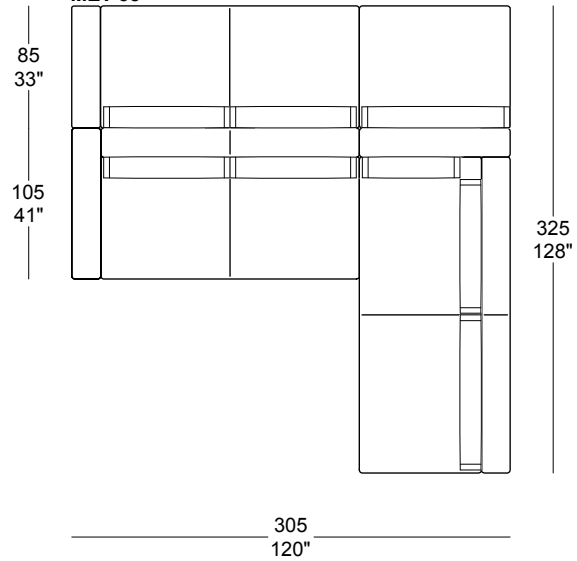

MET

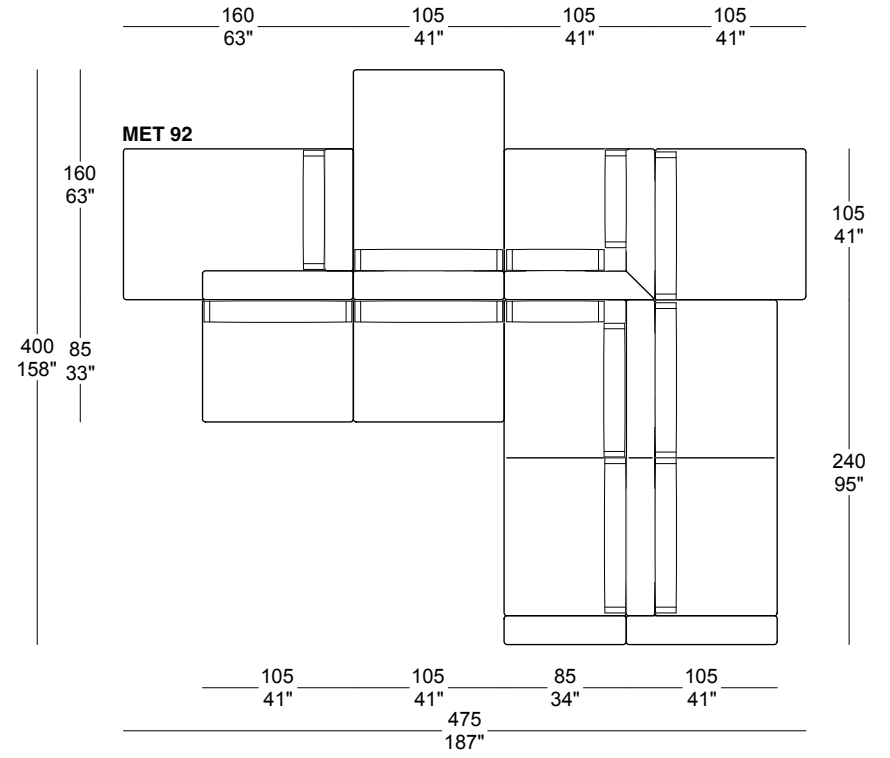
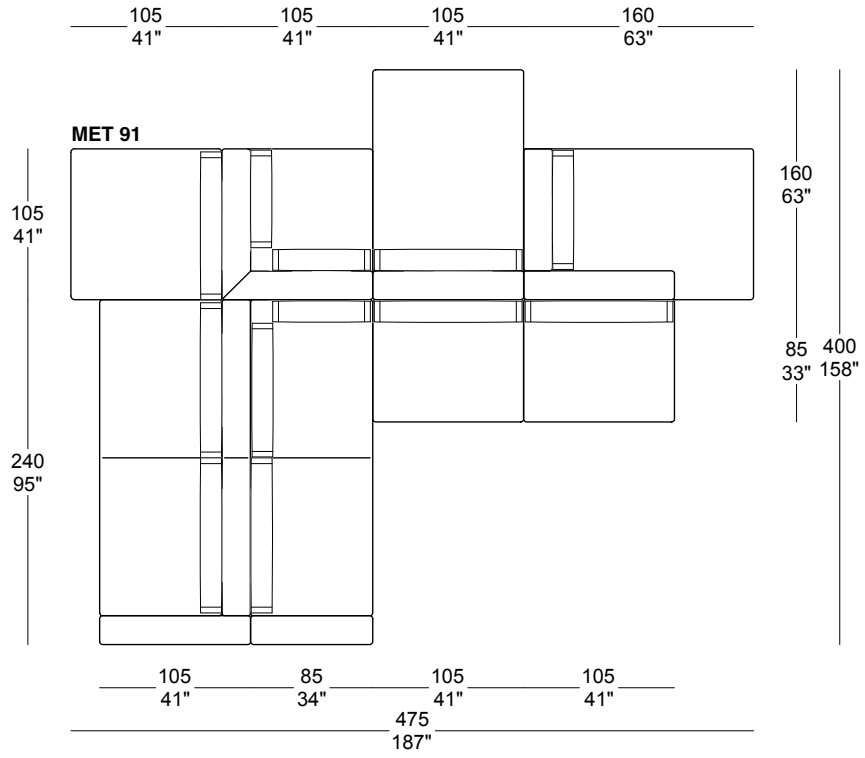

MET

MET 93

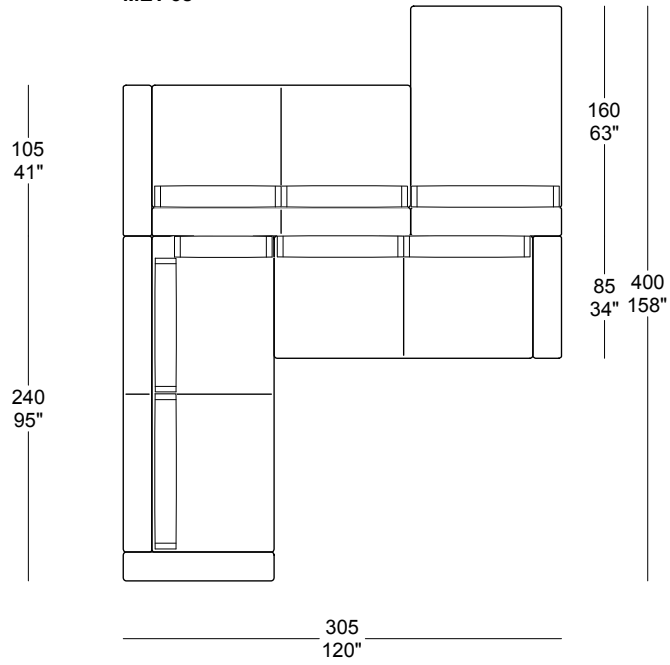

MET 94

