

1 ▶

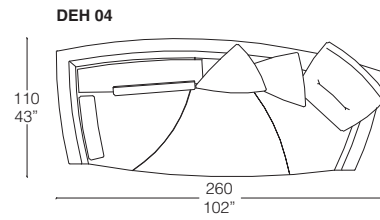

DEH 05

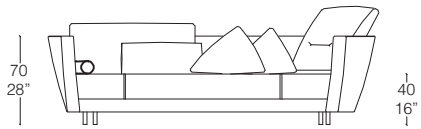
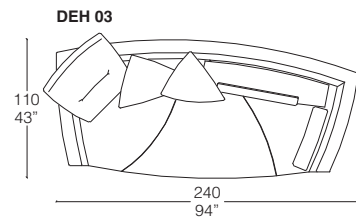
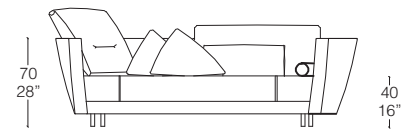
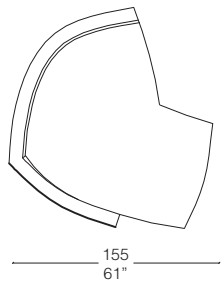

DEH 06

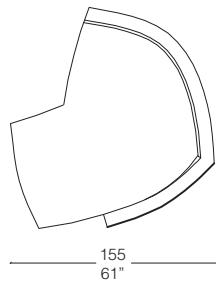

DEH 10

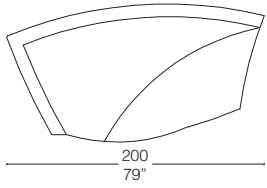

DEH 14

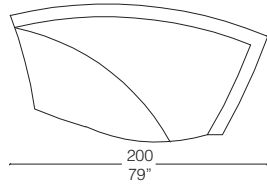

DEH 11

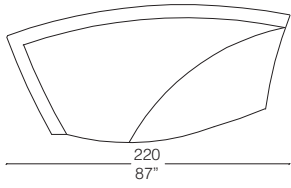

DEH 15

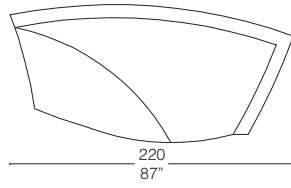

3 ►

DEH 12

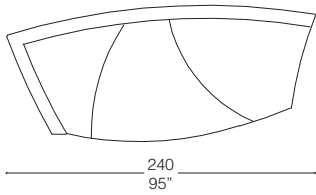

DEH 16

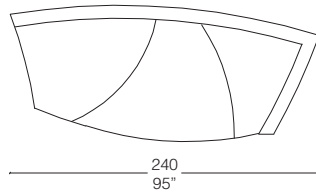

DEH 13

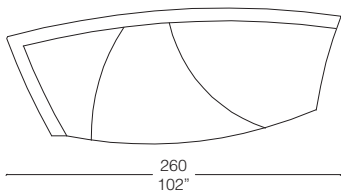

DEH 17

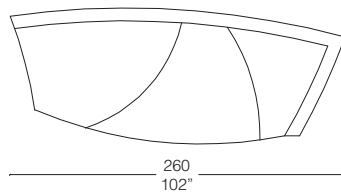

DEH 18

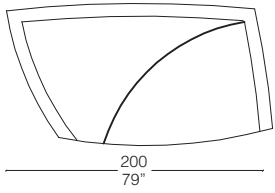

DEH 22

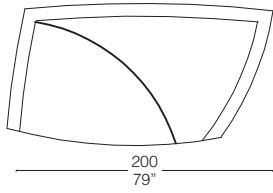

DEH 19

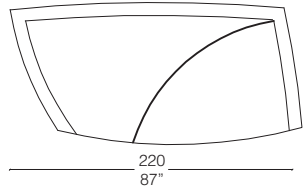

DEH 23

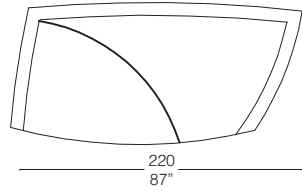

5 ▶

DEH 20

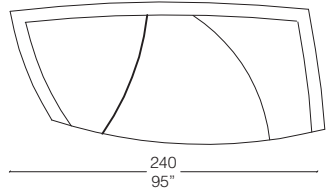

DEH 24

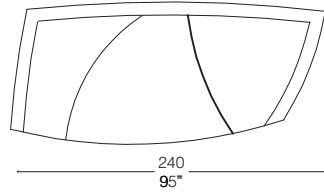

DEH 21

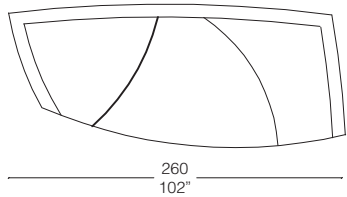

DEH 25

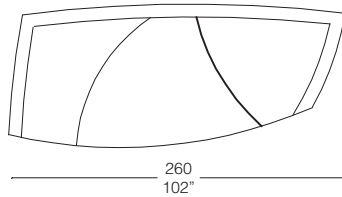

DEH 30

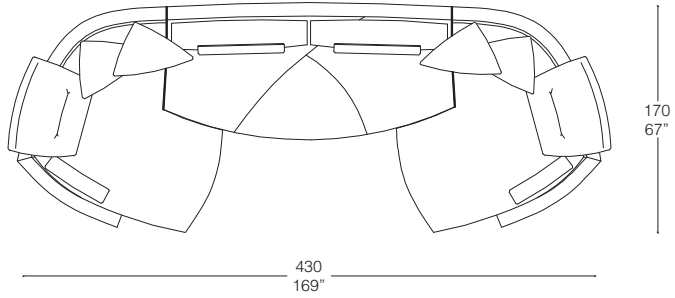

DEH 07

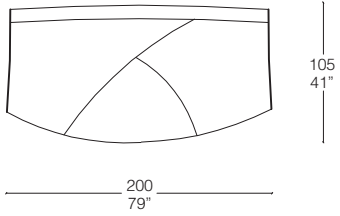

DEH 08

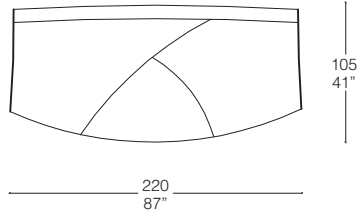

DEH 09

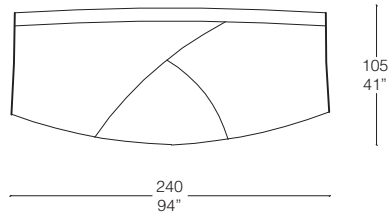

7 ▶

DEH 26

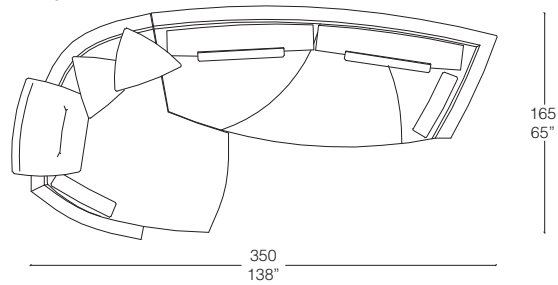

DEH 27

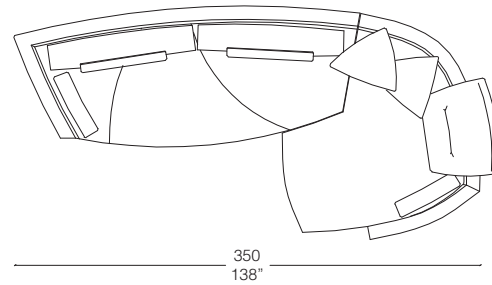

DEH 28

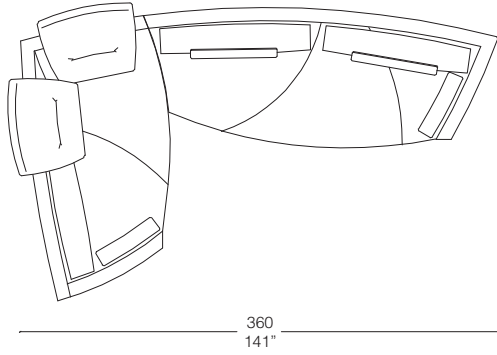

DEH 29

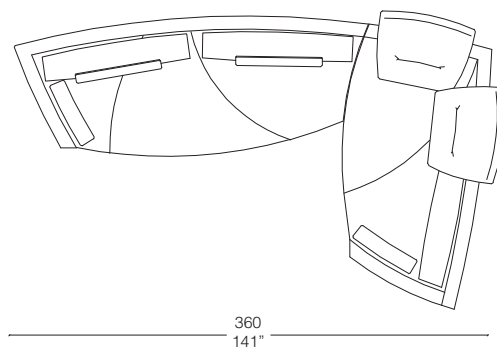

DEH 31

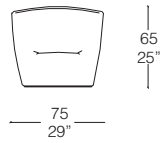

DEH 32

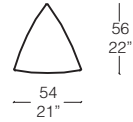

DEH 33

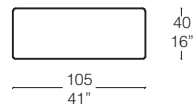

9 ▶

DEH 34

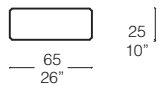

DEH 35

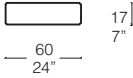

DEH 37

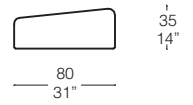

DEH 38

