

# FLAME OUTDOOR

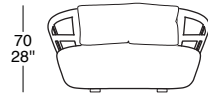

FLAO 01

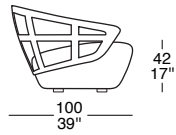
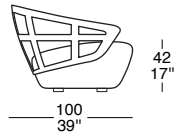
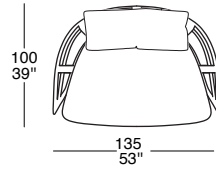

FLAO 02

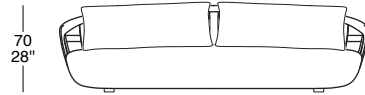
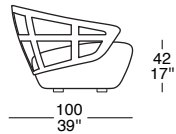
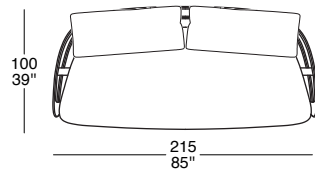

FLAO 03

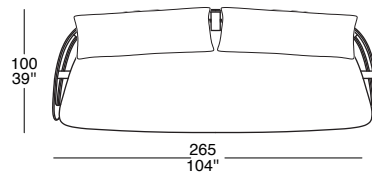

## CUSCINI / CUSHIONS

FLAO 04

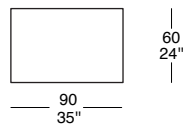

FLAO 05

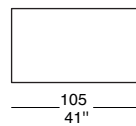

FLAO 06

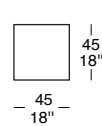

FLAO 07

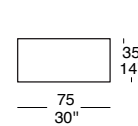

## POUFF

FLAO 10

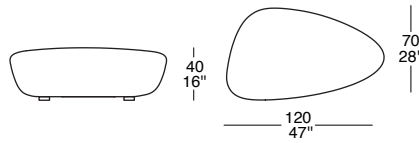

## TAVOLINO / LOW TABLE

FLAO 11

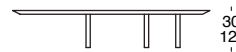
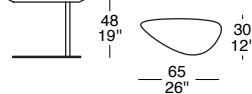

FLAO 12

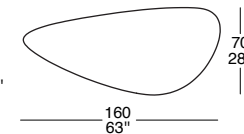

FLAO 13

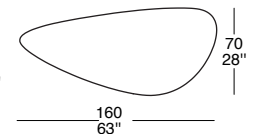

I prodotti della Collezione Outdoor sono stati testati per la collocazione da esterno, l'utilizzo ideale consigliato è per terrazzi e verande ed è buona norma proteggere gli articoli da esterno adottando accorgimenti che consentono di migliorarne la durata. È possibile acquistare l'apposito winter set che consente di proteggere meglio dalle intemperie i prodotti acquistati. Preghiamo accertarsi che tutti i prodotti siano completamente asciutti prima di coprirli per evitare accumuli di umidità o la formazione di macchie di muffa.

*The products in the Outdoor Collection have been tested so that may be used outside, ideally on terraces and verandas. Outdoor furniture should receive the correct care and maintenance to extend the life of the product.*

*Il Loft sells the special winter set which enables you to provide the best protection against bad weather for your purchases. Please ensure that all pieces of furniture are completely dry before covering them to prevent damp patches or the formation of mould stains.*

## NIKOS OUTDOOR

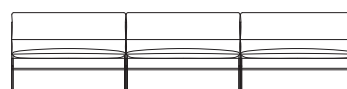
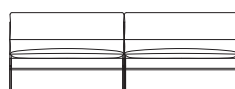
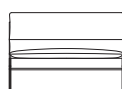
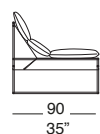

NK 01

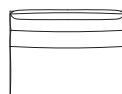

120  
47"

NK 02

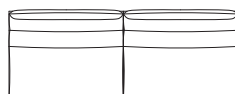

240  
94"

NK 03

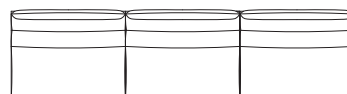

360  
142"

2 ▶

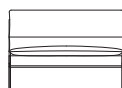
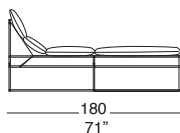

NK 04

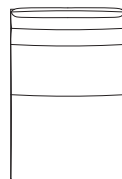

120  
47"

180  
71"

NK 05



45  
18"

I prodotti della Collezione Outdoor sono stati testati per la collocazione da esterno, l'utilizzo ideale consigliato è per terrazzi e verande ed è buona norma proteggere gli articoli da esterno adottando accorgimenti che consentono di migliorarne la durata.

È possibile acquistare l'apposito winter set che consente di proteggere meglio dalle intemperie i prodotti acquistati. Preghiamo accertarsi che tutti i prodotti siano completamente asciutti prima di coprirli per evitare accumuli di umidità o la formazione di macchie di muffa.

*The products in the Outdoor Collection have been tested so that may be used outside, ideally on terraces and verandas. Outdoor furniture should receive the correct care and maintenance to extend the life of the product. Il Loft sells the special winter set which enables you to provide the best protection against bad weather for your purchases. Please ensure that all pieces of furniture are completely dry before covering them to prevent damp patches or the formation of mould stains.*

**N.B.** Nelle composizioni, il tavolino è sempre previsto con il piano in vetro marmo.

**N.B.** In the compositions the low table is always provided with the marble glass top.

## NIKOS OUTDOOR

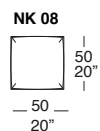
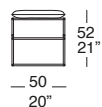
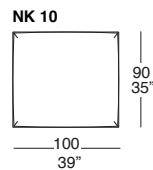
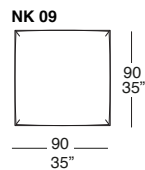
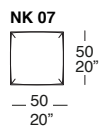
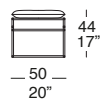

3 ▶

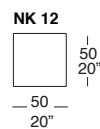
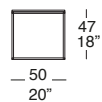
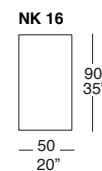
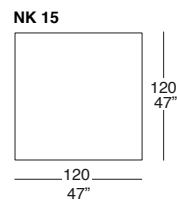
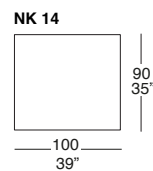
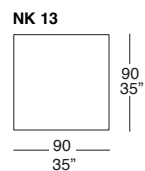
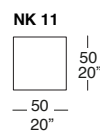
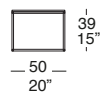

I prodotti della Collezione Outdoor sono stati testati per la collocazione da esterno, l'utilizzo ideale consigliato è per terrazzi e verande ed è buona norma proteggere gli articoli da esterno adottando accorgimenti che consentano di migliorarne la durata.

È possibile acquistare l'apposito winter set che consente di proteggere meglio dalle intemperie i prodotti acquistati. Preghiamo accertarsi che tutti i prodotti siano completamente asciutti prima di coprirli per evitare accumuli di umidità o la formazione di macchie di muffa.

*The products in the Outdoor Collection have been tested so that may be used outside, ideally on terraces and verandas. Outdoor furniture should receive the correct care and maintenance to extend the life of the product. Il Loft sells the special winter set which enables you to provide the best protection against bad weather for your purchases. Please ensure that all pieces of furniture are completely dry before covering them to prevent damp patches or the formation of mould stains.*

**N.B.** Nelle composizioni, il tavolino è sempre previsto con il piano in vetro marmo.

**N.B.** In the compositions the low table is always provided with the marble glass top.

## NIKOS OUTDOOR

NK 17

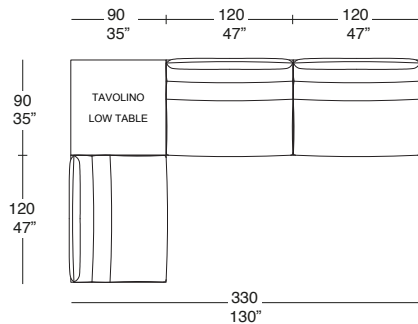

NK 18

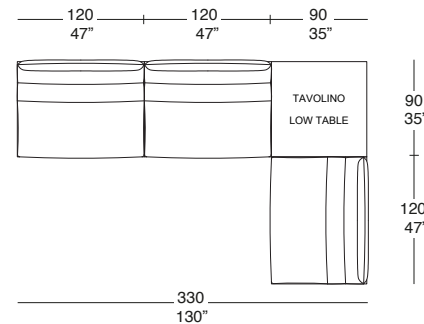

NK 19

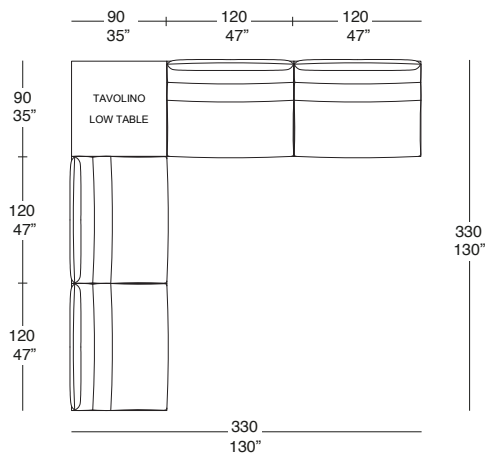

I prodotti della Collezione Outdoor sono stati testati per la collocazione da esterno, l'utilizzo ideale consigliato è per terrazzi e verande ed è buona norma proteggere gli articoli da esterno adottando accorgimenti che consentono di migliorarne la durata.

È possibile acquistare l'apposito winter set che consente di proteggere meglio dalle intemperie i prodotti acquistati. Preghiamo accertarsi che tutti i prodotti siano completamente asciutti prima di coprirli per evitare accumuli di umidità o la formazione di macchie di muffa.

*The products in the Outdoor Collection have been tested so that may be used outside, ideally on terraces and verandas. Outdoor furniture should receive the correct care and maintenance to extend the life of the product. Il Loft sells the special winter set which enables you to provide the best protection against bad weather for your purchases. Please ensure that all pieces of furniture are completely dry before covering them to prevent damp patches or the formation of mould stains.*

**N.B.** Nelle composizioni, il tavolino è sempre previsto con il piano in vetro marmo.

**N.B.** In the compositions the low table is always provided with the marble glass top.

## NIKOS OUTDOOR

NK 20

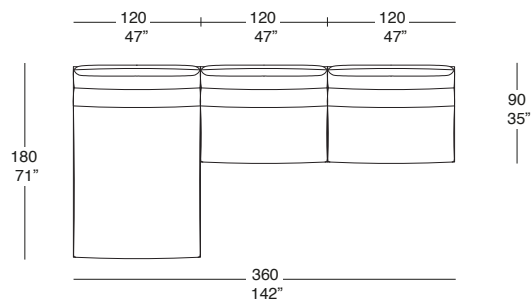

NK 21

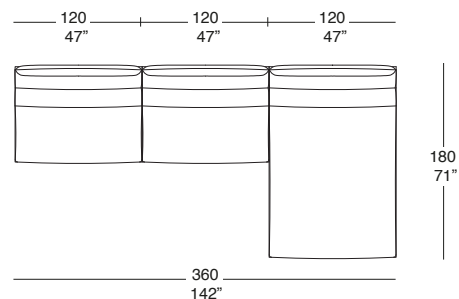

NK 22

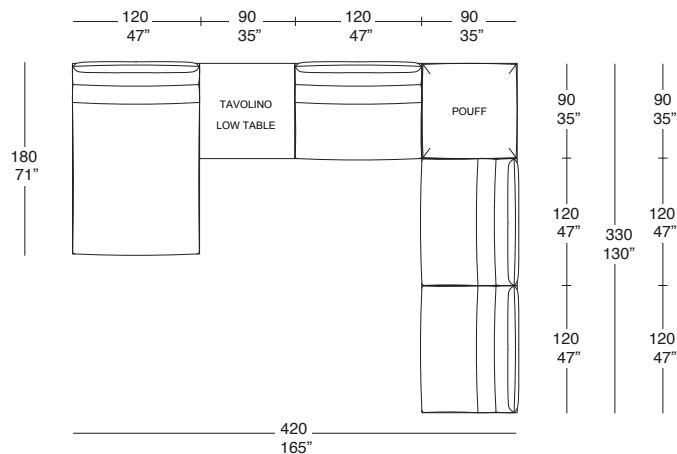

NK 23

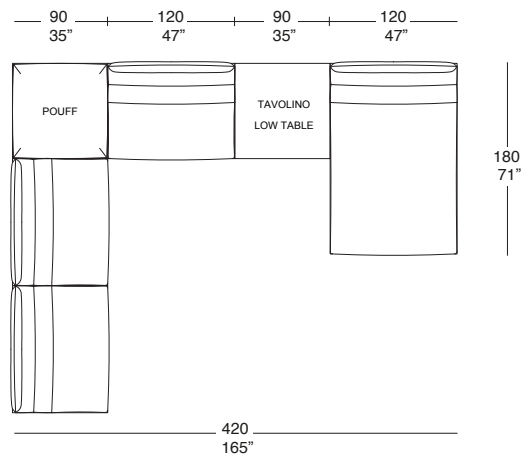

I prodotti della Collezione Outdoor sono stati testati per la collocazione da esterno, l'utilizzo ideale consigliato è per terrazzi e verande ed è buona norma proteggere gli articoli da esterno adottando accorgimenti che consentono di migliorarne la durata.

È possibile acquistare l'apposito winter set che consente di proteggere meglio dalle intemperie i prodotti acquistati. Preghiamo accertarsi che tutti i prodotti siano completamente asciutti prima di coprirli per evitare accumuli di umidità o la formazione di macchie di muffa.

*The products in the Outdoor Collection have been tested so that may be used outside, ideally on terraces and verandas. Outdoor furniture should receive the correct care and maintenance to extend the life of the product. Il Loft sells the special winter set which enables you to provide the best protection against bad weather for your purchases. Please ensure that all pieces of furniture are completely dry before covering them to prevent damp patches or the formation of mould stains.*

**N.B.** Nelle composizioni, il tavolino è sempre previsto con il piano in vetro marmo.

**N.B.** In the compositions the low table is always provided with the marble glass top.

# NIKOS OUTDOOR

NK 24

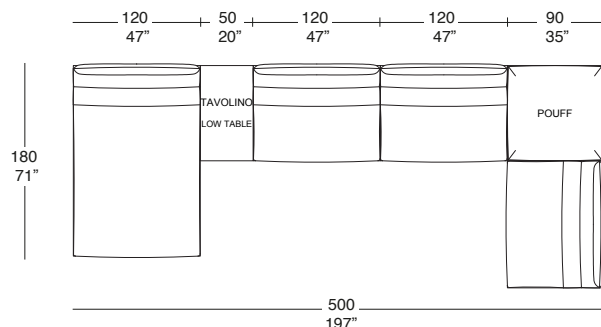

NK 25

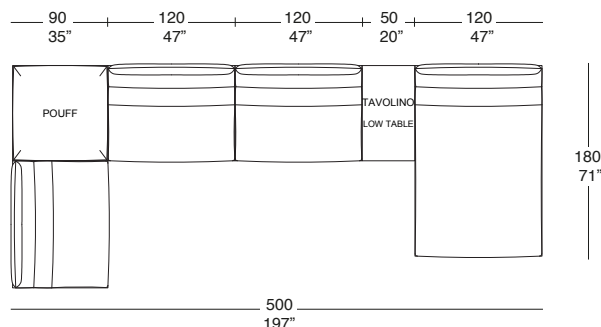

NK 26

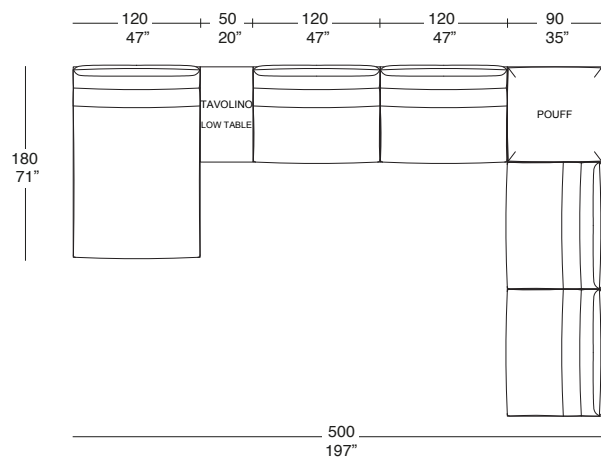

NK 27

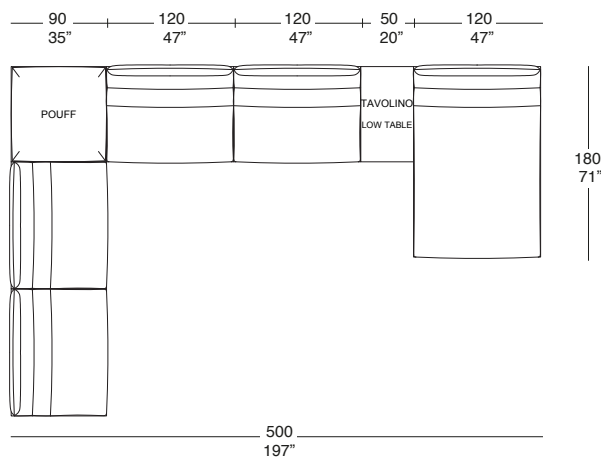

I prodotti della Collezione Outdoor sono stati testati per la collocazione da esterno, l'utilizzo ideale consigliato è per terrazzi e verande ed è buona norma proteggere gli articoli da esterno adottando accorgimenti che consentono di migliorarne la durata.

È possibile acquistare l'apposito winter set che consente di proteggere meglio dalle intemperie i prodotti acquistati. Preghiamo accertarsi che tutti i prodotti siano completamente asciutti prima di coprirli per evitare accumuli di umidità o la formazione di macchie di muffa.

*The products in the Outdoor Collection have been tested so that may be used outside, ideally on terraces and verandas. Outdoor furniture should receive the correct care and maintenance to extend the life of the product. Il Loft sells the special winter set which enables you to provide the best protection against bad weather for your purchases. Please ensure that all pieces of furniture are completely dry before covering them to prevent damp patches or the formation of mould stains.*

**N.B.** Nelle composizioni, il tavolino è sempre previsto con il piano in vetro marmo.

**N.B.** In the compositions the low table is always provided with the marble glass top.

# SOLLER OUTDOOR

STRUTTURA ELEMENTO SINGOLO  
SINGLE ELEMENT FRAME

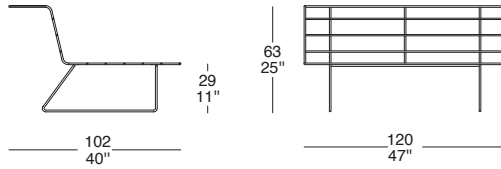

SOL 01

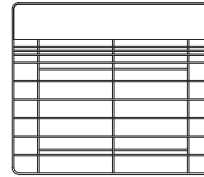

CUSCINO SEDUTA/SCHIENALE EL. SINGOLO  
SINGLE EL. SEAT/BACK CUSHION

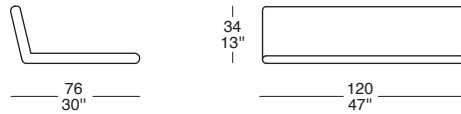

SOL 02



CUSC. SEDUTA/SCHIENALE C/MENSOLA EL. SINGOLO  
SINGLE EL. SEAT/BACK CUSH. W/SHELF

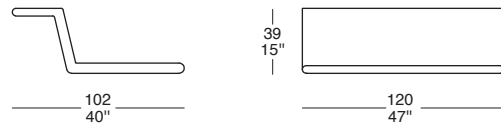

SOL 03

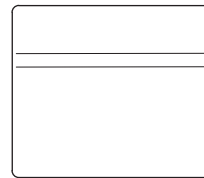

EL. SINGOLO CON CUSCINO SEDUTA/SCHIENALE  
SINGLE EL. W/ SINGLE SEAT/BACK CUSHION

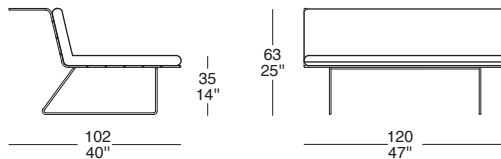

SOL 04

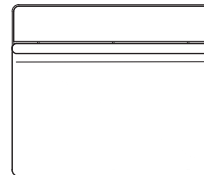

EL. SINGOLO CON CUSC. SEDUTA/SCHIENALE C/MENSOLA  
SINGLE EL. W/ SINGLE SEAT/BACK CUSH. W/SHELF

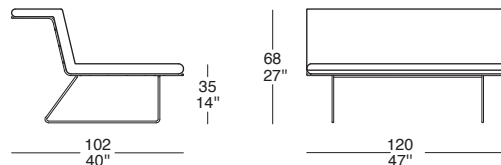

SOL 05



CUSCINI  
CUSHIONS  
SOL 06

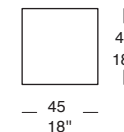

SOL 07

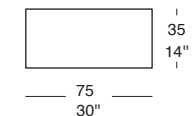

I prodotti della Collezione Outdoor sono stati testati per la collocazione da esterno, l'utilizzo ideale consigliato è per terrazze e verande ed è buona norma proteggere gli articoli da esterno adottando accorgimenti che consentono di migliorarne la durata. È possibile acquistare l'apposito winter set che consente di proteggere meglio dalle intemperie i prodotti acquistati. Preghiamo accertarsi che tutti i prodotti siano completamente asciutti prima di coprirli per evitare accumuli di umidità o la formazione di macchie di muffa.

*The products in the Outdoor Collection have been tested so that may be used outside, ideally on terraces and verandas. Outdoor furniture should receive the correct care and maintenance to extend the life of the product.*

*Il Loft sells the special winter set which enables you to provide the best protection against bad weather for your purchases. Please ensure that all pieces of furniture are completely dry before covering them to prevent damp patches or the formation of mould stains.*

## SOLLER OUTDOOR

STRUTTURA ANGOLO  
CORNER ELEMENT FRAME

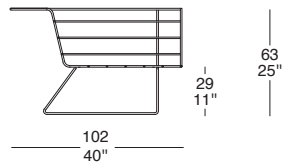

SOL 08

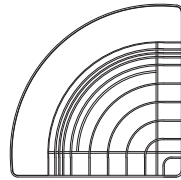

CUSCINO SEDUTA/SCHIENALE ANGOLO  
CORNER SEAT/BACK CUSHION

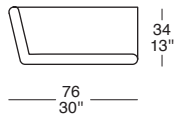

SOL 09

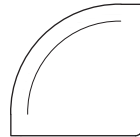

CUSC. SEDUTA/SCHIENALE C/MENSOLA ANGOLO  
CORNER SEAT/BACK CUSH. W/SHELF

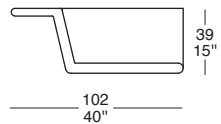

SOL 10

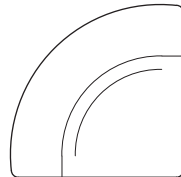

ANGOLO CON CUSCINO SEDUTA/SCHIENALE  
CORNER W/SEAT/BACK CUSHION

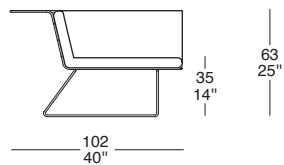

SOL 11

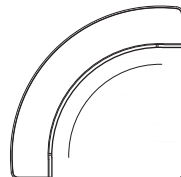

ANGOLO C/CUSC. SEDUTA/SCHIENALE C/MENSOLA  
ANGOLO W/SEAT/BACK CUSH/SHELF

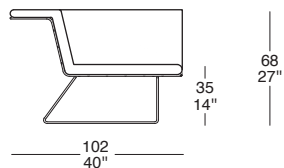

SOL 12

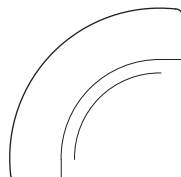

I prodotti della Collezione Outdoor sono stati testati per la collocazione da esterno, l'utilizzo ideale consigliato è per terrazzi e verande ed è buona norma proteggere gli articoli da esterno adottando accorgimenti che consentono di migliorarne la durata.

È possibile acquistare l'apposito winter set che consente di proteggere meglio dalle intemperie i prodotti acquistati. Preghiamo accertarsi che tutti i prodotti siano completamente asciutti prima di coprirli per evitare accumuli di umidità o la formazione di macchie di muffa.

*The products in the Outdoor Collection have been tested so that may be used outside, ideally on terraces and verandas. Outdoor furniture should receive the correct care and maintenance to extend the life of the product. Il Loft sells the special winter set which enables you to provide the best protection against bad weather for your purchases. Please ensure that all pieces of furniture are completely dry before covering them to prevent damp patches or the formation of mould stains.*



## SOLLER OUTDOOR

### STRUTTURA POUFF OTTOMAN FRAME

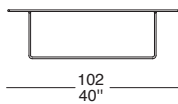
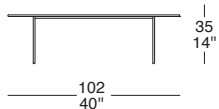

### SOL 13

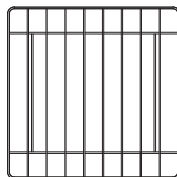

### CUSCINO POUFF OTTOMAN SEAT CUSHION

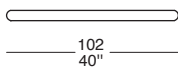
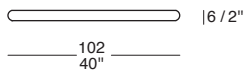

### SOL 14

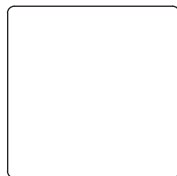

### POUFF CON CUSCINO OTTOMAN WITH CUSHION

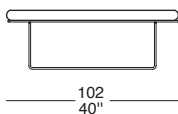
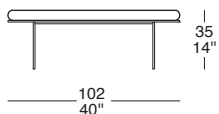

### SOL 15

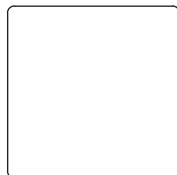

I prodotti della Collezione Outdoor sono stati testati per la collocazione da esterno, l'utilizzo ideale consigliato è per terrazzi e verande ed è buona norma proteggere gli articoli da esterno adottando accorgimenti che consentono di migliorarne la durata.

È possibile acquistare l'apposito winter set che consente di proteggere meglio dalle intemperie i prodotti acquistati. Preghiamo accertarsi che tutti i prodotti siano completamente asciutti prima di coprirli per evitare accumuli di umidità o la formazione di macchie di muffa.

*The products in the Outdoor Collection have been tested so that may be used outside, ideally on terraces and verandas. Outdoor furniture should receive the correct care and maintenance to extend the life of the product. Il Loft sells the special winter set which enables you to provide the best protection against bad weather for your purchases. Please ensure that all pieces of furniture are completely dry before covering them to prevent damp patches or the formation of mould stains.*

## SOLLER OUTDOOR

STRUTTURA CHAISE LONGUE  
CHAISE LONGUE FRAME

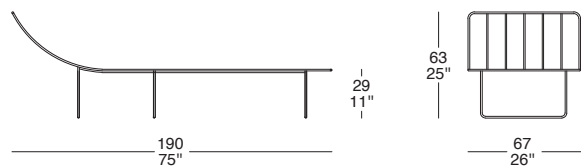

SOL 16



CUSCINO CHAISE LONGUE  
CHAISE LONGUE SEAT CUSHION

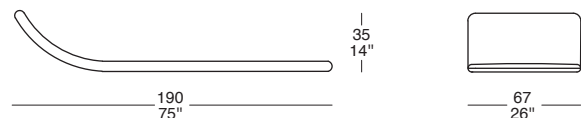

SOL 17



CHAISE LONGUE CON CUSCINO  
CHAISE LONGUE WITH CUSHION

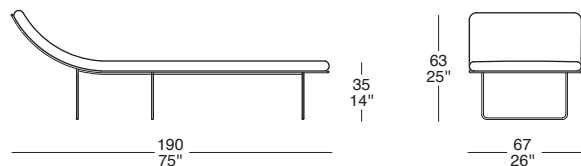

SOL 18

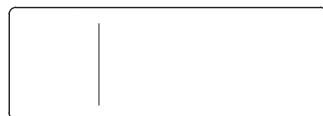

10 ►

I prodotti della Collezione Outdoor sono stati testati per la collocazione da esterno, l'utilizzo ideale consigliato è per terrazze e verande ed è buona norma proteggere gli articoli da esterno adottando accorgimenti che consentono di migliorarne la durata.

È possibile acquistare l'apposito winter set che consente di proteggere meglio dalle intemperie i prodotti acquistati. Preghiamo accertarsi che tutti i prodotti siano completamente asciutti prima di coprirli per evitare accumuli di umidità o la formazione di macchie di muffa.

*The products in the Outdoor Collection have been tested so that may be used outside, ideally on terraces and verandas. Outdoor furniture should receive the correct care and maintenance to extend the life of the product. Il Loft sells the special winter set which enables you to provide the best protection against bad weather for your purchases. Please ensure that all pieces of furniture are completely dry before covering them to prevent damp patches or the formation of mould stains.*

## SOLLER OUTDOOR

STRUTTURA CHAISE LONGUE  
CHAISE LONGUE FRAME

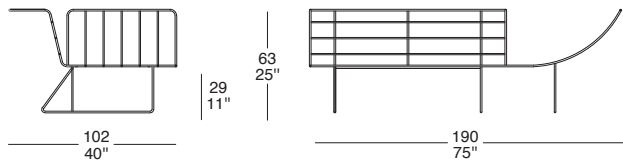

SOL 19  
SX

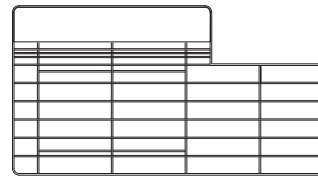

SOL 24  
DX

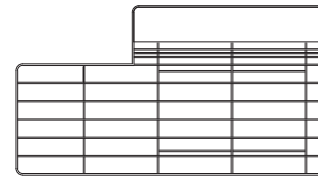

CUSCINO SEDUTA/SCHIENALE CHAISE LONGUE  
CHAISE LONGUE SEAT/BACK CUSHION

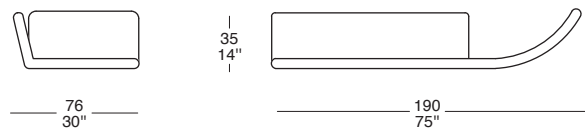

SOL 20  
SX

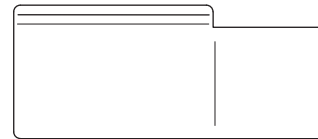

SOL 25  
DX

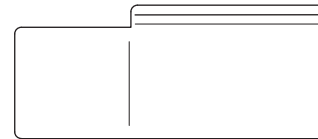

CUSCINO SEDUTA/SCHIENALE C/ MENSOLA CHAISE LONGUE  
CHAISE LONGUE SEAT/BACK/SHELF CUSHION

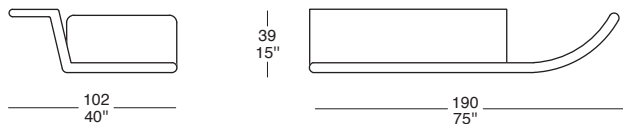

SOL 21  
SX

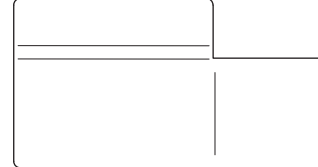

SOL 26  
DX

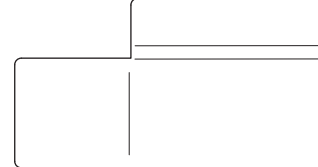

CHAISE LONGUE CON CUSCINO SEDUTA/SCHIENALE  
CHAISE LONGUE WITH SEAT/BACK CUSHION

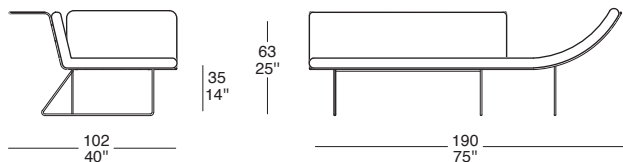

SOL 22  
SX

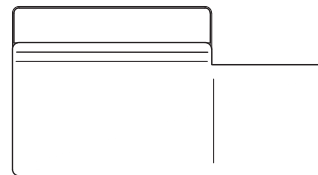

SOL 27  
DX

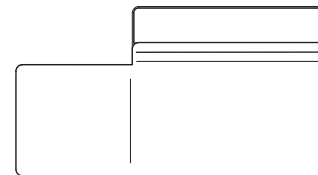

CHAISE LONGUE CON CUSCINO SEDUTA/SCHIENALE C/MENSOLA  
CHAISE LONGUE WITH SEAT/BACK/SHELF CUSHION

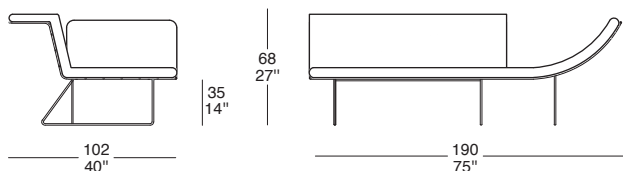

SOL 23  
SX

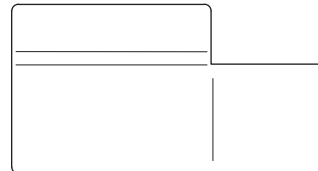

SOL 28  
DX

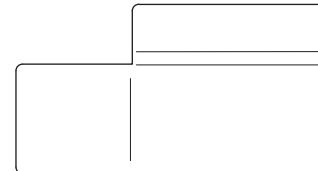

I prodotti della Collezione Outdoor sono stati testati per la collocazione da esterno, l'utilizzo ideale consigliato è per terrazze e verande ed è buona norma proteggere gli articoli da esterno adottando accorgimenti che consentono di migliorarne la durata.

È possibile acquistare l'apposito winter set che consente di proteggere meglio dalle intemperie i prodotti acquistati. Preghiamo accertarsi che tutti i prodotti siano completamente asciutti prima di coprirli per evitare accumuli di umidità o la formazione di macchie di muffa.

*The products in the Outdoor Collection have been tested so that may be used outside, ideally on terraces and verandas. Outdoor furniture should receive the correct care and maintenance to extend the life of the product. Il Loft sells the special winter set which enables you to provide the best protection against bad weather for your purchases. Please ensure that all pieces of furniture are completely dry before covering them to prevent damp patches or the formation of mould stains.*

## SOLLER OUTDOOR

STRUTTURA ELEMENTO SPICCHIO  
SPICCHIO ELEMENT FRAME

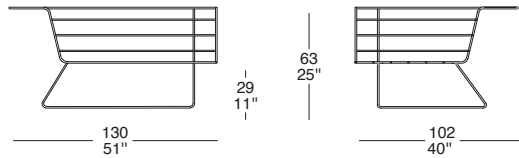

SOL 29  
SX

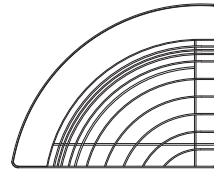

SOL 34  
DX

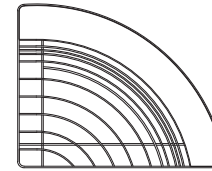

CUSC.SEDUTA/SCHIENALE SPICCHIO  
SPICCHIO SEAT/BACK CUSHION

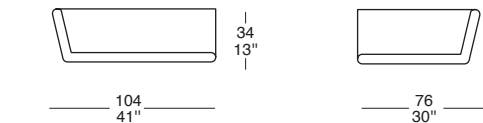

SOL 30  
SX

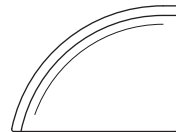

SOL 35  
DX

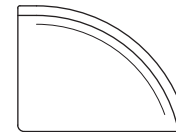

CUSC.SEDUTA/SCHIENALE C.MENSOLA SPICCHIO  
SPICCHIO SEAT/BACK/SHELF CUSHION

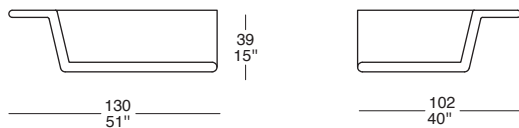

SOL 31  
SX

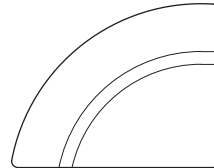

SOL 36  
DX

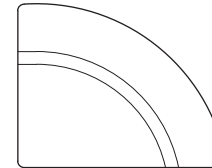

EL. SPICCHIO CON CUSCINO SEDUTA/SCHIENALE  
SPICCHIO EL. WITH SEAT/BACK CUSHION

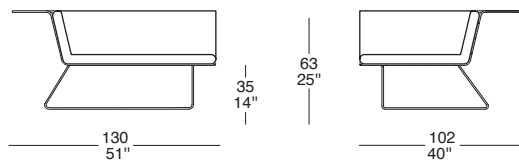

SOL 32  
SX

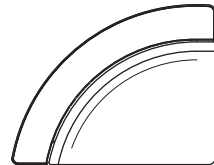

SOL 37  
DX

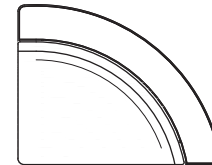

EL. SPICCHIO CON CUSC.SEDUTA/SCHIENALE C/MENSOLA  
SPICCHIO EL. W/SEAT/BACK CUSH. W/SHELF

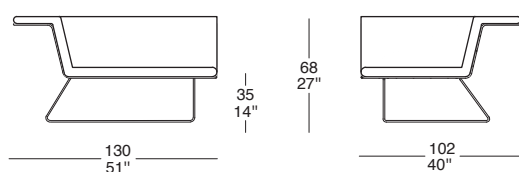

SOL 33  
SX

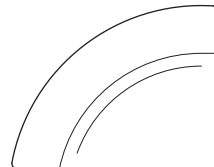

SOL 38  
DX

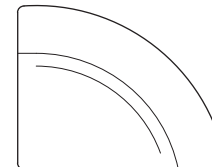

I prodotti della Collezione Outdoor sono stati testati per la collocazione da esterno, l'utilizzo ideale consigliato è per terrazzi e verande ed è buona norma proteggere gli articoli da esterno adottando accorgimenti che consentono di migliorarne la durata.

È possibile acquistare l'apposito winter set che consente di proteggere meglio dalle intemperie i prodotti acquistati. Preghiamo accertarsi che tutti i prodotti siano completamente asciutti prima di coprirli per evitare accumuli di umidità o la formazione di macchie di muffa.

*The products in the Outdoor Collection have been tested so that may be used outside, ideally on terraces and verandas. Outdoor furniture should receive the correct care and maintenance to extend the life of the product. Il Loft sells the special winter set which enables you to provide the best protection against bad weather for your purchases. Please ensure that all pieces of furniture are completely dry before covering them to prevent damp patches or the formation of mould stains.*

## SOLLER OUTDOOR

COMP SPICCHIO C/CUSCINO SEDUTA  
SPICCHIO GROUP W/SEAT/BACK CUSHION

SOL 39

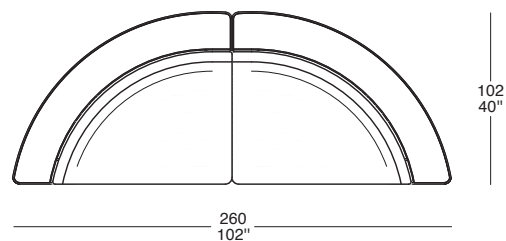

COMP SPICCHIO C/CUSCINO SEDUTA CON MENSOLA  
SPICCHIO GROUP W/SEAT/BACK/SHELF CUSHION

SOL 40

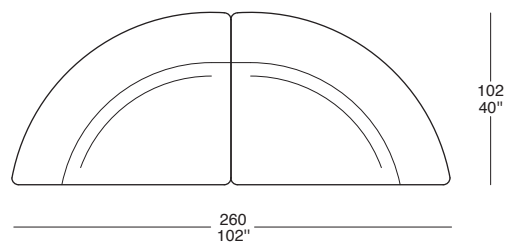

13 ►

I prodotti della Collezione Outdoor sono stati testati per la collocazione da esterno, l'utilizzo ideale consigliato è per terrazzi e verande ed è buona norma proteggere gli articoli da esterno adottando accorgimenti che consentono di migliorarne la durata.

È possibile acquistare l'apposito winter set che consente di proteggere meglio dalle intemperie i prodotti acquistati. Preghiamo accertarsi che tutti i prodotti siano completamente asciutti prima di coprirli per evitare accumuli di umidità o la formazione di macchie di muffa.

*The products in the Outdoor Collection have been tested so that may be used outside, ideally on terraces and verandas. Outdoor furniture should receive the correct care and maintenance to extend the life of the product. Il Loft sells the special winter set which enables you to provide the best protection against bad weather for your purchases. Please ensure that all pieces of furniture are completely dry before covering them to prevent damp patches or the formation of mould stains.*

## SOLLER OUTDOOR

STRUTTURA ELEMENTO ROTONDO  
ROUND ELEMENT FRAME

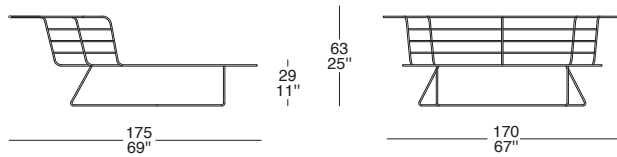

SOL 41

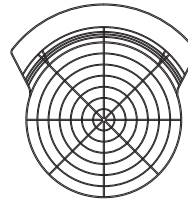

CUSC.SEDUTA/SCHIENALE ELEMENTO ROTONDO  
ROUND SEAT/BACK CUSHION

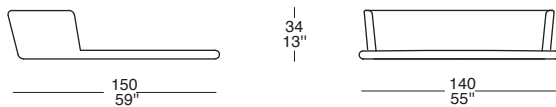

SOL 42

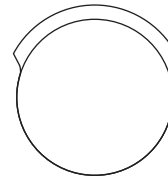

CUSC.SEDUTA/SCHIENALE C.MENSOLA ROTONDO  
ROUND SEAT/BACK/SHELF CUSHION

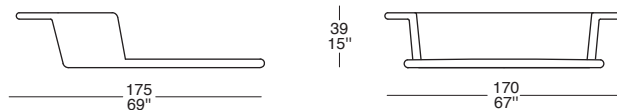

SOL 43

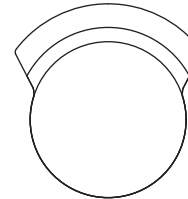

EL. ROTONDO CON CUSCINO SEDUTA/SCHIENALE  
ROUND EL. WITH SEAT/BACK CUSHION

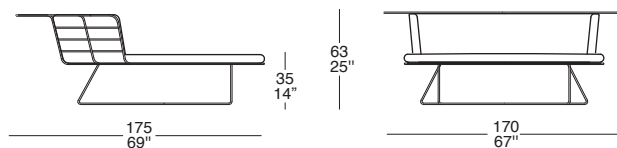

SOL 44

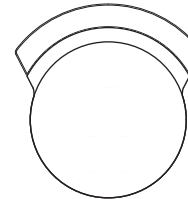

EL. ROTONDO CON CUSC.SEDUTA/SCHIENALE C/MENSOLA  
ROUND EL. W/SEAT/BACK CUSH. W/SHELF

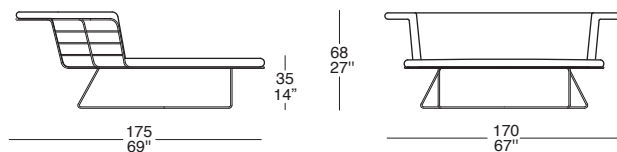

SOL 45

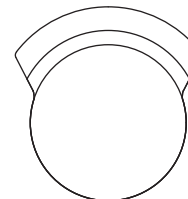

I prodotti della Collezione Outdoor sono stati testati per la collocazione da esterno, l'utilizzo ideale consigliato è per terrazzi e verande ed è buona norma proteggere gli articoli da esterno adottando accorgimenti che consentono di migliorarne la durata.

È possibile acquistare l'apposito winter set che consente di proteggere meglio dalle intemperie i prodotti acquistati. Preghiamo accertarsi che tutti i prodotti siano completamente asciutti prima di coprirli per evitare accumuli di umidità o la formazione di macchie di muffa.

*The products in the Outdoor Collection have been tested so that may be used outside, ideally on terraces and verandas. Outdoor furniture should receive the correct care and maintenance to extend the life of the product. Il Loft sells the special winter set which enables you to provide the best protection against bad weather for your purchases. Please ensure that all pieces of furniture are completely dry before covering them to prevent damp patches or the formation of mould stains.*

# SOLLER OUTDOOR

COMP C/CUSCINO SEDUTA/SCHIENALE  
GROUP W/SEAT/BACK CUSHION

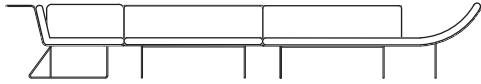

SOL 46

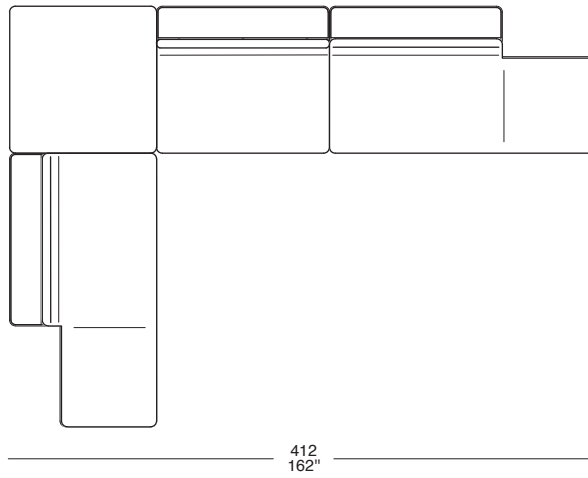

SOL 47

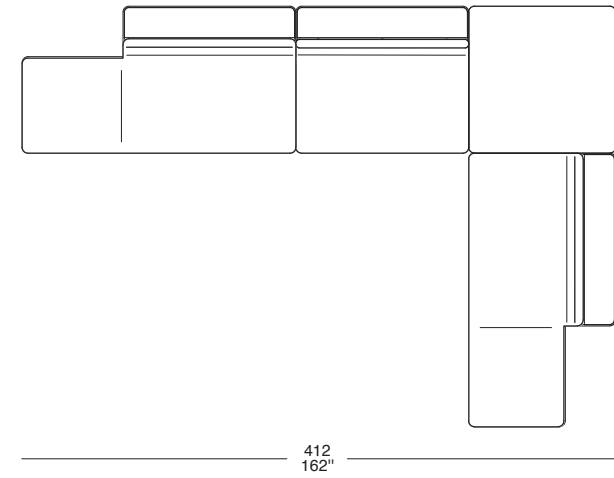

15 ▶

COMP C/CUSCINO SEDUTA/SCHIENALE C. MENSOLA  
GROUP W/SEAT/BACK/SHELF CUSHION

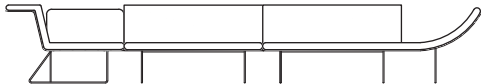

SOL 48

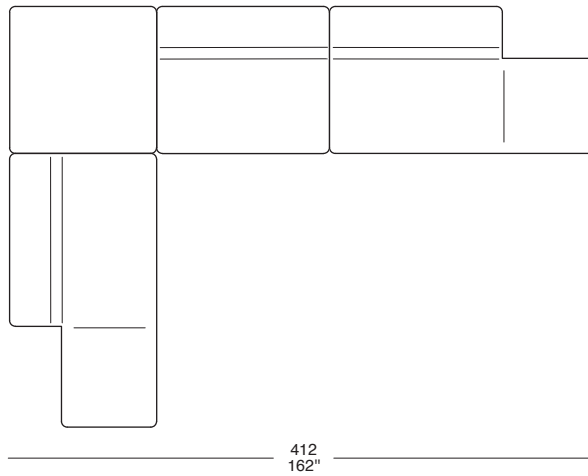

SOL 49

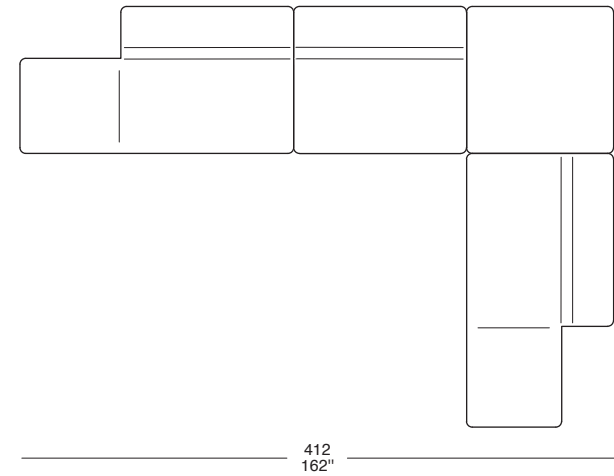

# SOLLER OUTDOOR

COMP C/CUSCINO SEDUTA/SCHIENALE  
GROUP W/SEAT/BACK CUSHION

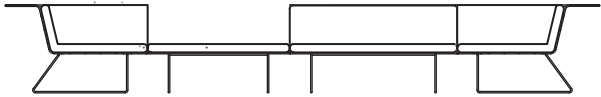

SOL 50

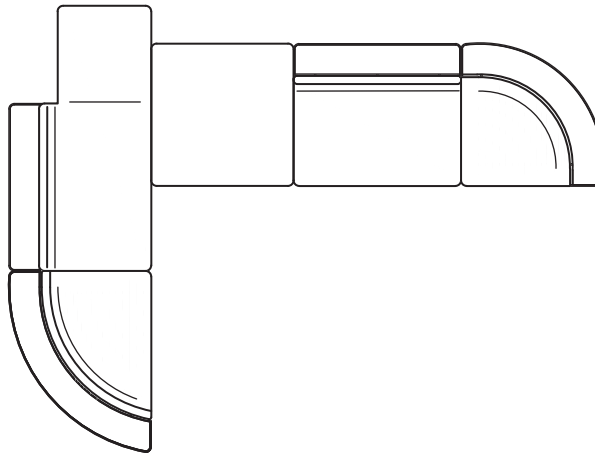

426  
168"

SOL 51

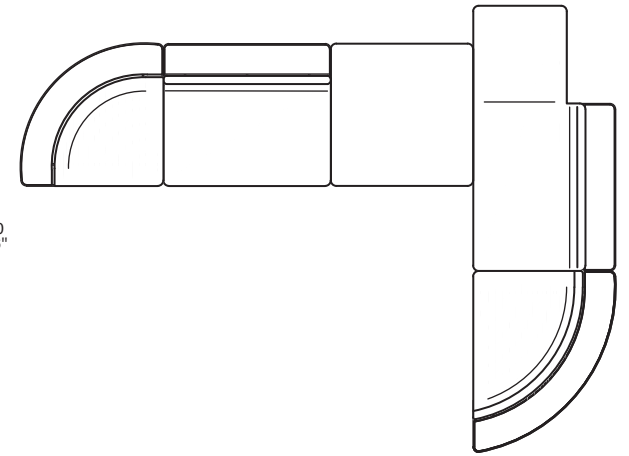

426  
168"

320  
126"

16 ▶

COMP C/CUSCINO SEDUTA/SCHIENALE C. MENSOLA  
GROUP W/SEAT/BACK/SHELF CUSHION

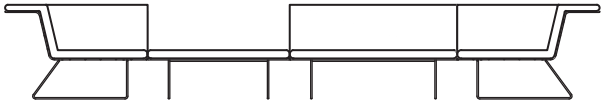

SOL 52

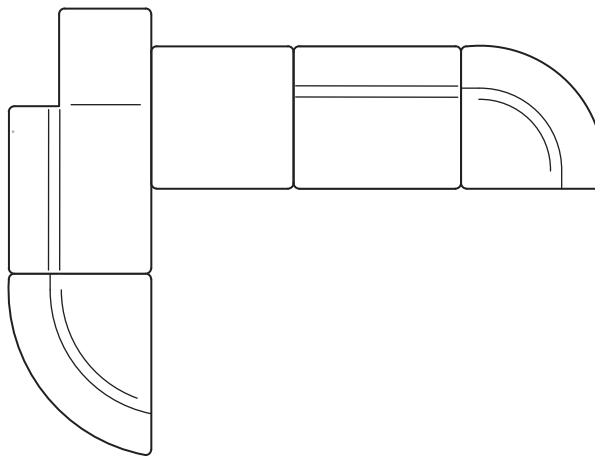

426  
168"

SOL 53

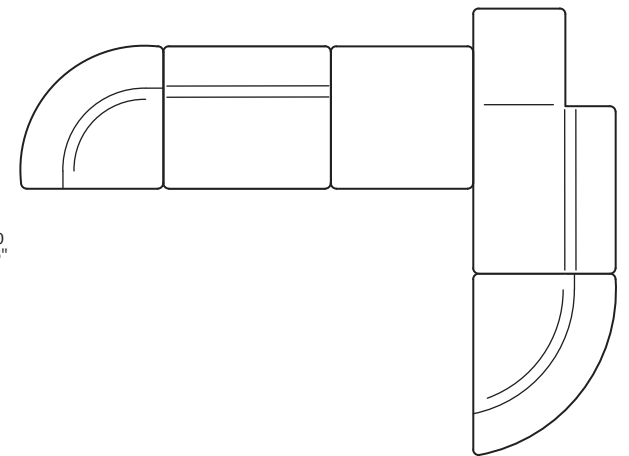

426  
168"

320  
126"



# SOLLER OUTDOOR

COMP C/CUSCINO SEDUTA/SCHIENALE  
GROUP W/SEAT/BACK CUSHION

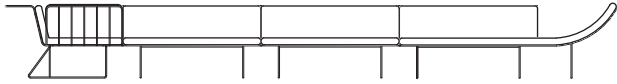

SOL 54

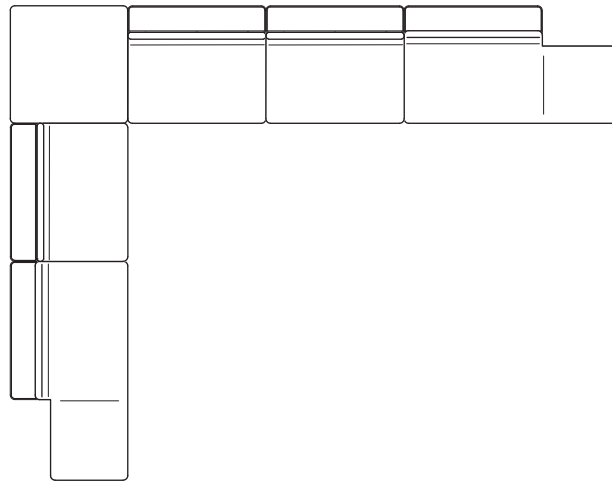

532  
209"

SOL 55

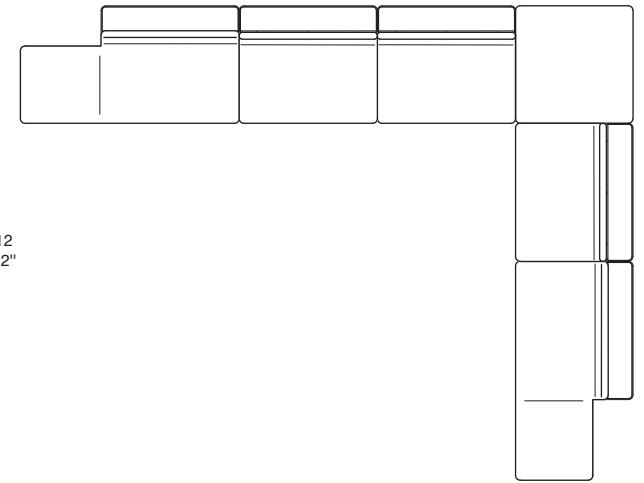

412  
162"

532  
209"

17 ▶

COMP C/CUSCINO SEDUTA/SCHIENALE C. MENSOLA  
GROUP W/SEAT/BACK/SHELF CUSHION



SOL 56

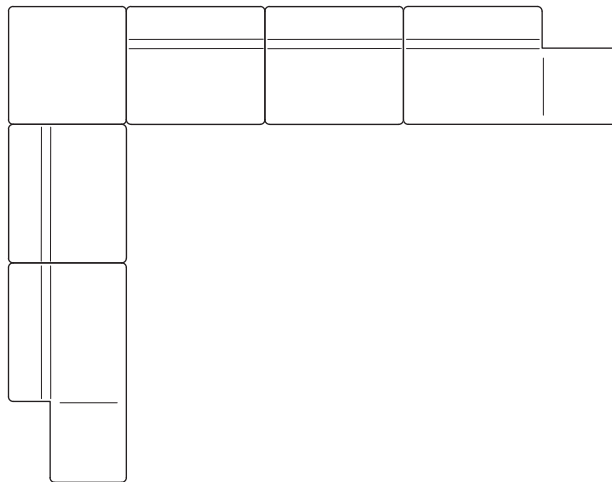

532  
209"

SOL 57

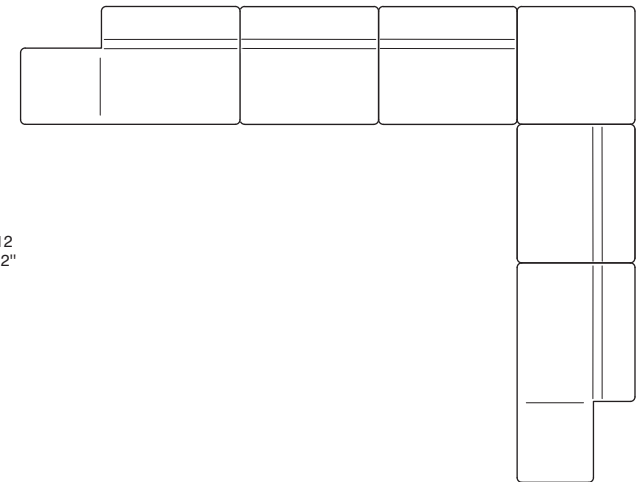

412  
162"

532  
209"

# SOLLER OUTDOOR

COMP C/CUSCINO SEDUTA/SCHIENALE  
GROUP W/SEAT/BACK CUSHION

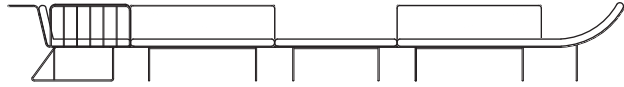

SOL 58

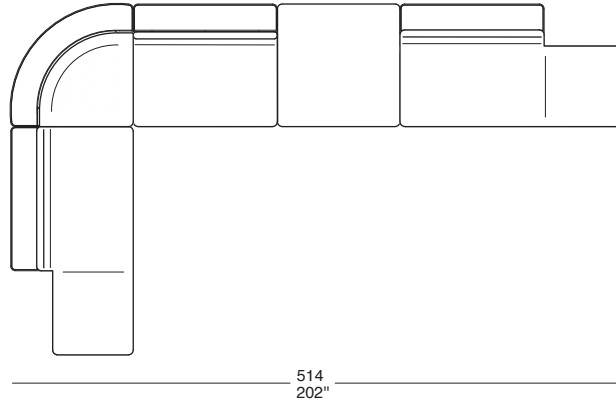

SOL 59

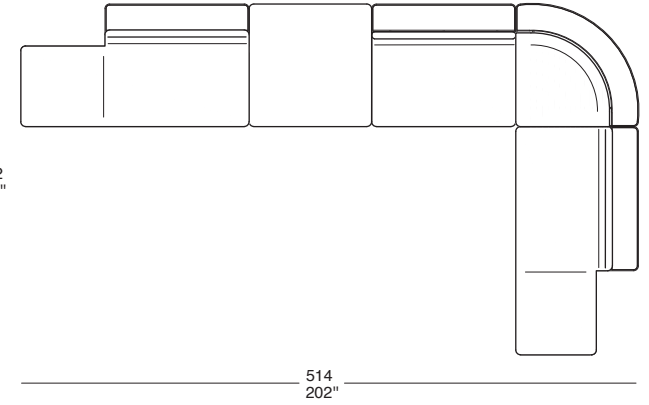

18 ►

COMP C/CUSCINO SEDUTA/SCHIENALE C. MENSOLA  
GROUP W/SEAT/BACK/SHELF CUSHION

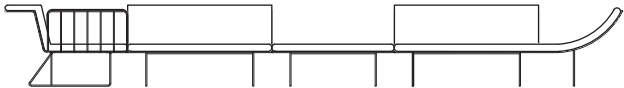

SOL 60

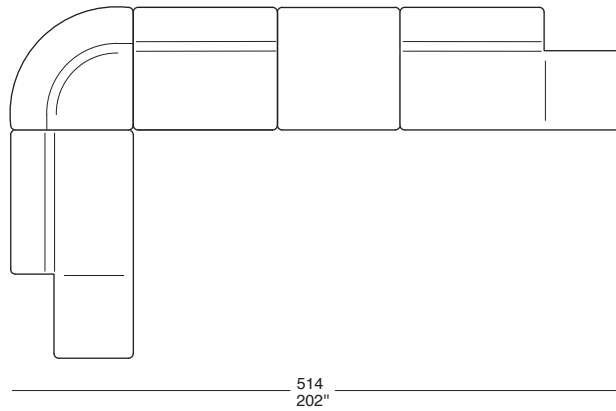

SOL 61

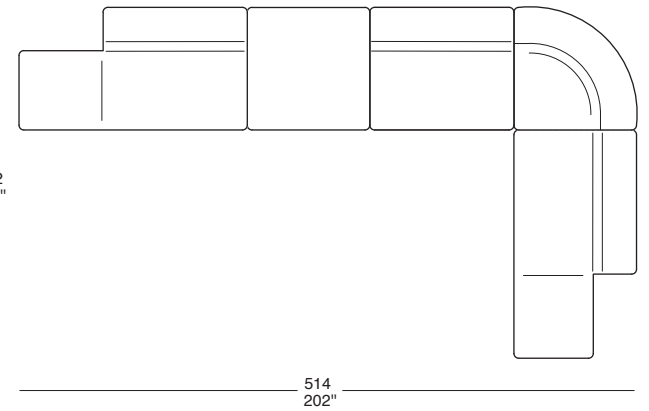

## SOLLER OUTDOOR TAVOLINO

TAVOLINO  
LOW TABLE

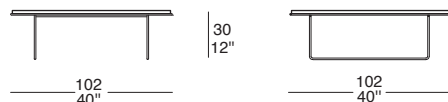

SOL 80

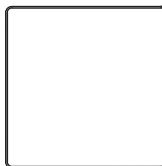

19 ►

TAVOLINO  
LOW TABLE

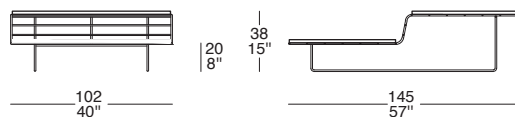

SOL 81

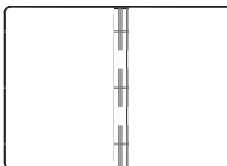

I prodotti della Collezione Outdoor sono stati testati per la collocazione da esterno, l'utilizzo ideale consigliato è per terrazzi e verande ed è buona norma proteggere gli articoli da esterno adottando accorgimenti che consentono di migliorarne la durata.

È possibile acquistare l'apposito winter set che consente di proteggere meglio dalle intemperie i prodotti acquistati. Preghiamo accertarsi che tutti i prodotti siano completamente asciutti prima di coprirli per evitare accumuli di umidità o la formazione di macchie di muffa.

*The products in the Outdoor Collection have been tested so that may be used outside, ideally on terraces and verandas. Outdoor furniture should receive the correct care and maintenance to extend the life of the product. Il Loft sells the special winter set which enables you to provide the best protection against bad weather for your purchases. Please ensure that all pieces of furniture are completely dry before covering them to prevent damp patches or the formation of mould stains.*

# SOLLER OUTDOOR PANCA

**PANCA DIRITTA**  
*STRAIGHT BENCH*

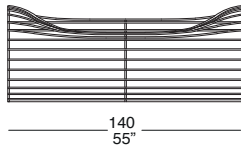
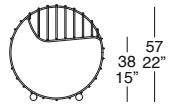

**SOP 01**

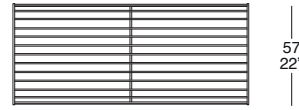

**CUSCINO SEDUTA DRITTA**  
*STRAIGHT SEAT CUSHION*

**SOP 02**



**PANCA ELEMENTO CURVO**  
*BENCH CURVED ELEMENT*

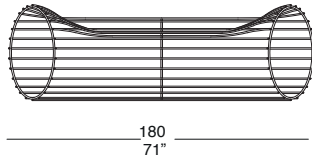
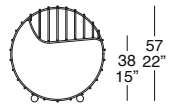

**SOP 03**

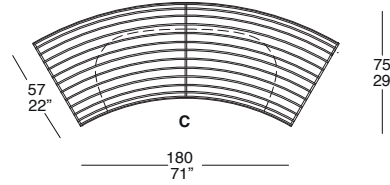

**CUSCINO SEDUTA CURVO**  
*CURVED SEAT CUSHION*

**SOP 04**



**PANCA ELEMENTO CURVO SX**  
*BENCH CURVED ELEMENT LEFT*

**SOP 05**

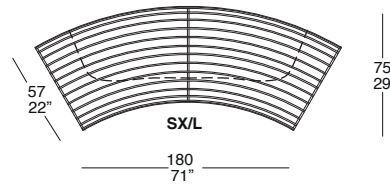

**SOP 04**



**PANCA ELEMENTO CURVO DX**  
*BENCH CURVED ELEMENT RIGHT*

**SOP 06**

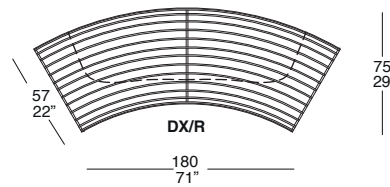

**SOP 04**



SOLLER OUTDOOR PANCA

SOP 07

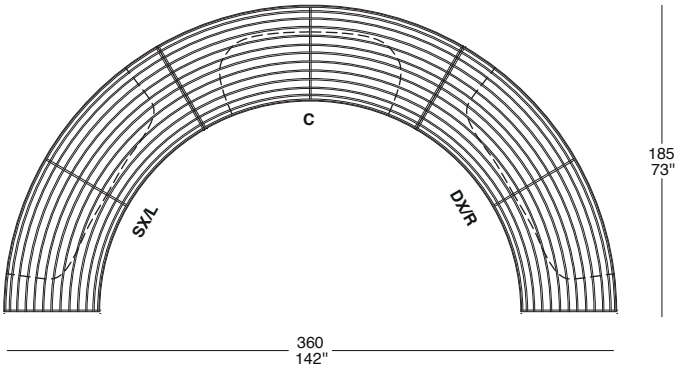

SOP 08

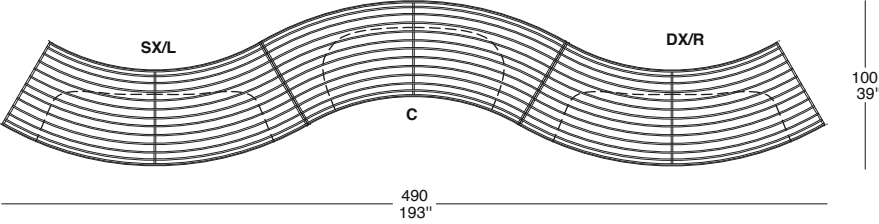

21 ▶

SOP 09 SX

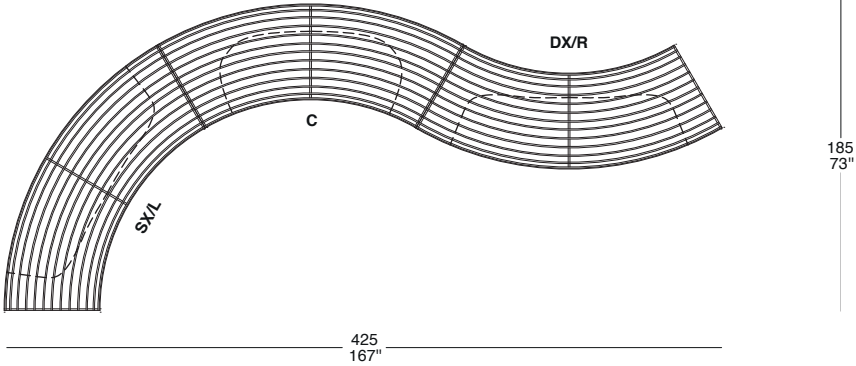

SOP 10 DX

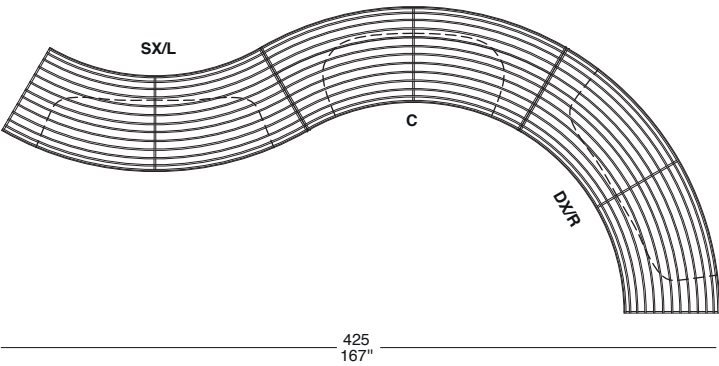

## SUPER ROY OUTDOOR

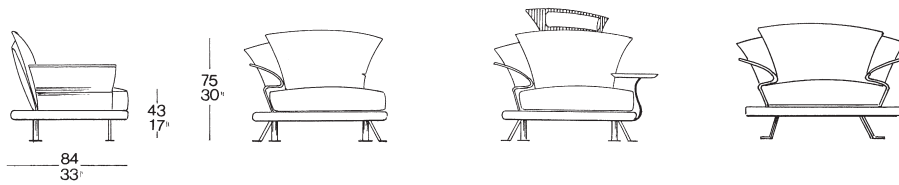

SRO 09

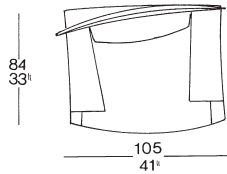

SRO 04

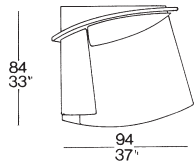

SRO 05

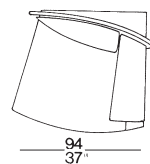

SRO 06

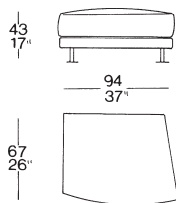

SRO 30

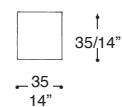

SRO 08

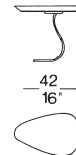

SRO 07

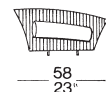

SRO 111



SRO 112



I prodotti della Collezione Outdoor sono stati testati per la collocazione da esterno, l'utilizzo ideale consigliato è per terrazzi e verande ed è buona norma proteggere gli articoli da esterno adottando accorgimenti che consentono di migliorarne la durata. È possibile acquistare l'apposito winter set che consente di proteggere meglio dalle intemperie i prodotti acquistati. Preghiamo accertarsi che tutti i prodotti siano completamente asciutti prima di coprirli per evitare accumuli di umidità o la formazione di macchie di muffa.

*The products in the Outdoor Collection have been tested so that may be used outside, ideally on terraces and verandas. Outdoor furniture should receive the correct care and maintenance to extend the life of the product. Il Loft sells the special winter set which enables you to provide the best protection against bad weather for your purchases. Please ensure that all pieces of furniture are completely dry before covering them to prevent damp patches or the formation of mould stains.*

## SUPER ROY OUTDOOR

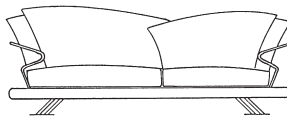
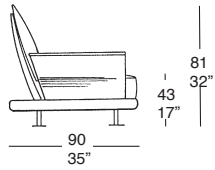

SRO 01

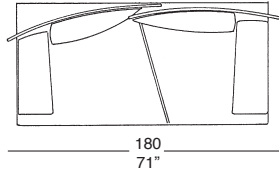

SRO 02

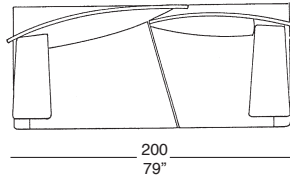

SRO 03

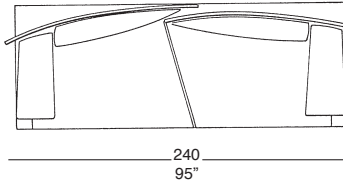

SRO 18

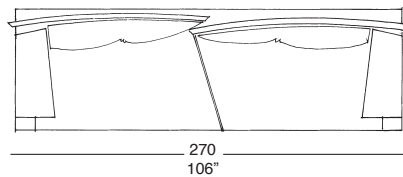

SRO 19

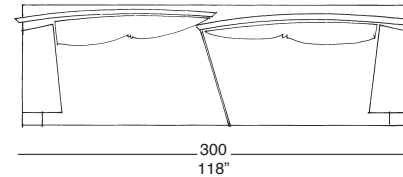

I prodotti della Collezione Outdoor sono stati testati per la collocazione da esterno, l'utilizzo ideale consigliato è per terrazze e verande ed è buona norma proteggere gli articoli da esterno adottando accorgimenti che consentono di migliorarne la durata.

È possibile acquistare l'apposito winter set che consente di proteggere meglio dalle intemperie i prodotti acquistati. Preghiamo accertarsi che tutti i prodotti siano completamente asciutti prima di coprirli per evitare accumuli di umidità o la formazione di macchie di muffa.

*The products in the Outdoor Collection have been tested so that may be used outside, ideally on terraces and verandas. Outdoor furniture should receive the correct care and maintenance to extend the life of the product.*

*Il Loft sells the special winter set which enables you to provide the best protection against bad weather for your purchases. Please ensure that all pieces of furniture are completely dry before covering them to prevent damp patches or the formation of mould stains.*

## SUPER ROY OUTDOOR CHAISE LONGUE

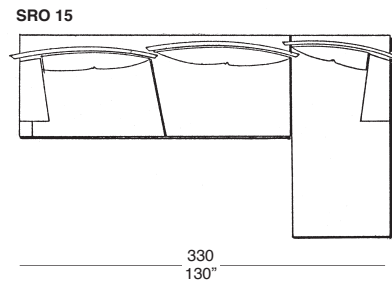
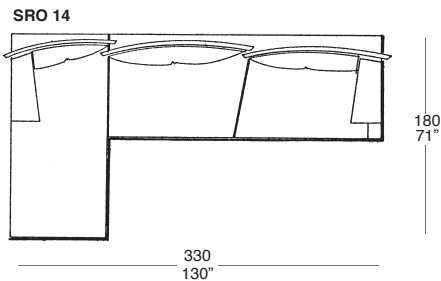
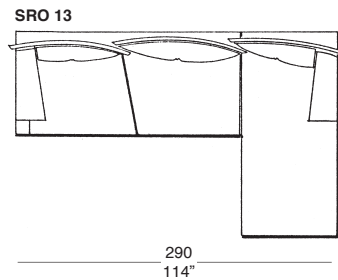
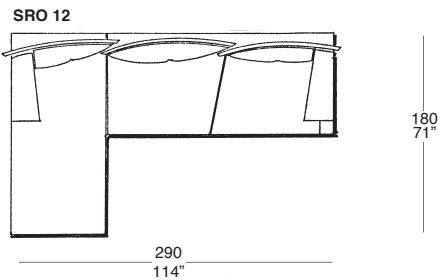
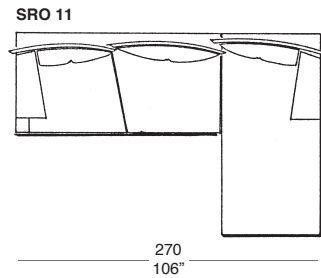
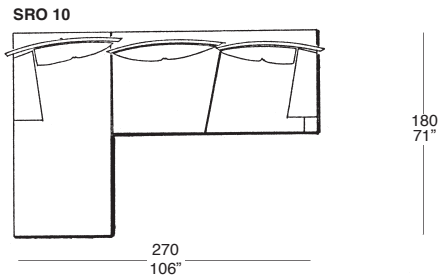
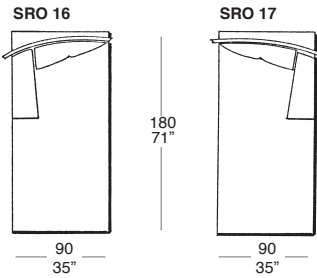

I prodotti della Collezione Outdoor sono stati testati per la collocazione da esterno, l'utilizzo ideale consigliato è per terrazzi e verande ed è buona norma proteggere gli articoli da esterno adottando accorgimenti che consentono di migliorarne la durata.

È possibile acquistare l'apposito winter set che consente di proteggere meglio dalle intemperie i prodotti acquistati. Preghiamo accertarsi che tutti i prodotti siano completamente asciutti prima di coprirli per evitare accumuli di umidità o la formazione di macchie di muffa.

*The products in the Outdoor Collection have been tested so that may be used outside, ideally on terraces and verandas. Outdoor furniture should receive the correct care and maintenance to extend the life of the product.*

*Il Loft sells the special winter set which enables you to provide the best protection against bad weather for your purchases. Please ensure that all pieces of furniture are completely dry before covering them to prevent damp patches or the formation of mould stains.*



## SUPER ROY OUTDOOR ANGOLARE

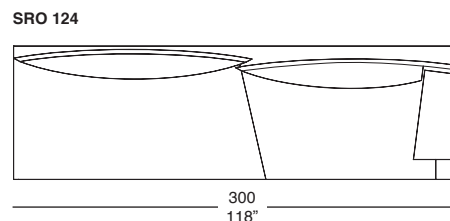
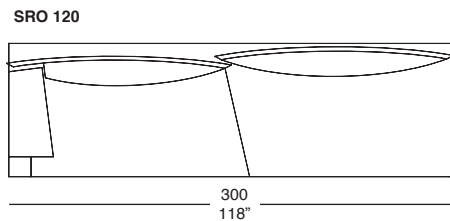
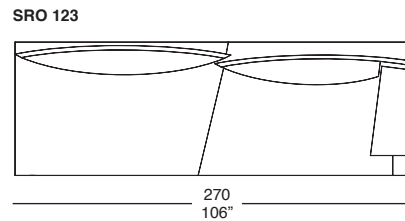
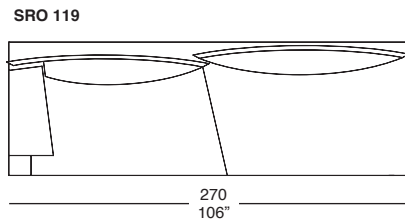
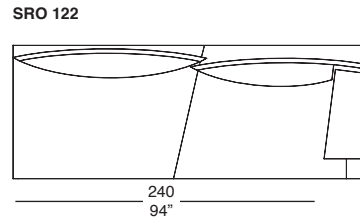
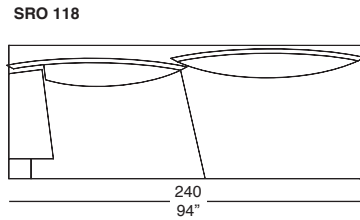
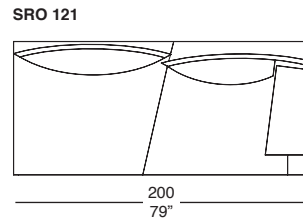
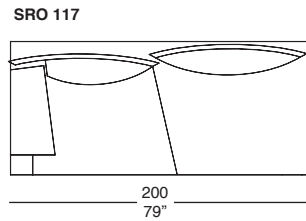
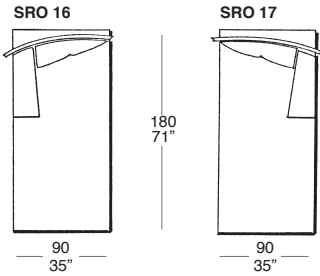

25 ▶

I prodotti della Collezione Outdoor sono stati testati per la collocazione da esterno, l'utilizzo ideale consigliato è per terrazzi e verande ed è buona norma proteggere gli articoli da esterno adottando accorgimenti che consentono di migliorarne la durata.

È possibile acquistare l'apposito winter set che consente di proteggere meglio dalle intemperie i prodotti acquistati. Preghiamo accertarsi che tutti i prodotti siano completamente asciutti prima di coprirli per evitare accumuli di umidità o la formazione di macchie di muffa.

*The products in the Outdoor Collection have been tested so that may be used outside, ideally on terraces and verandas. Outdoor furniture should receive the correct care and maintenance to extend the life of the product. Il Loft sells the special winter set which enables you to provide the best protection against bad weather for your purchases. Please ensure that all pieces of furniture are completely dry before covering them to prevent damp patches or the formation of mould stains.*

## SUPER ROY OUTDOOR ANGOLARE

SRO 125

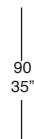
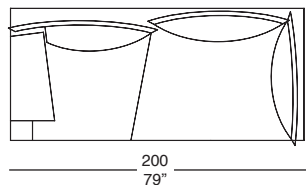

SRO 129

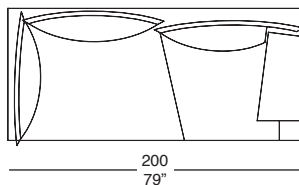

SRO 126

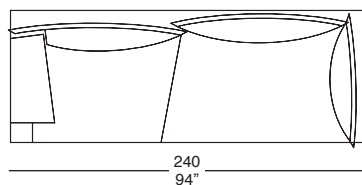

SRO 130

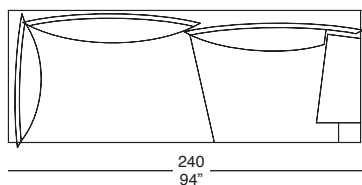

26 ►

SRO 127

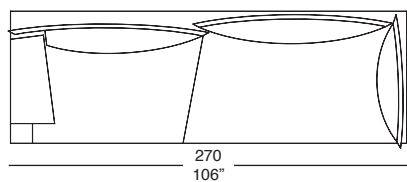

SRO 131

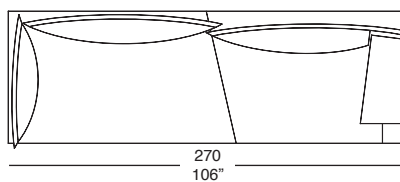

SRO 128

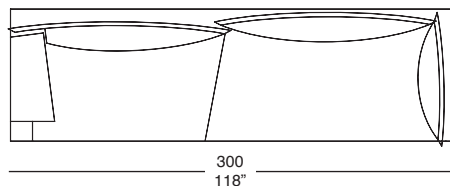

SRO 132

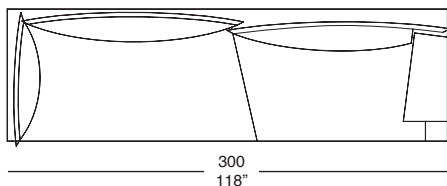

I prodotti della Collezione Outdoor sono stati testati per la collocazione da esterno, l'utilizzo ideale consigliato è per terrazzi e verande ed è buona norma proteggere gli articoli da esterno adottando accorgimenti che consentono di migliorarne la durata.

È possibile acquistare l'apposito winter set che consente di proteggere meglio dalle intemperie i prodotti acquistati. Preghiamo accertarsi che tutti i prodotti siano completamente asciutti prima di coprirli per evitare accumuli di umidità o la formazione di macchie di muffa

*The products in the Outdoor Collection have been tested so that may be used outside, ideally on terraces and verandas. Outdoor furniture should receive the correct care and maintenance to extend the life of the product. Il Loft sells the special winter set which enables you to provide the best protection against bad weather for your purchases. Please ensure that all pieces of furniture are completely dry before covering them to prevent damp patches or the formation of mould stains.*

## SUPER ROY OUTDOOR ANGOLARE

SRO 133

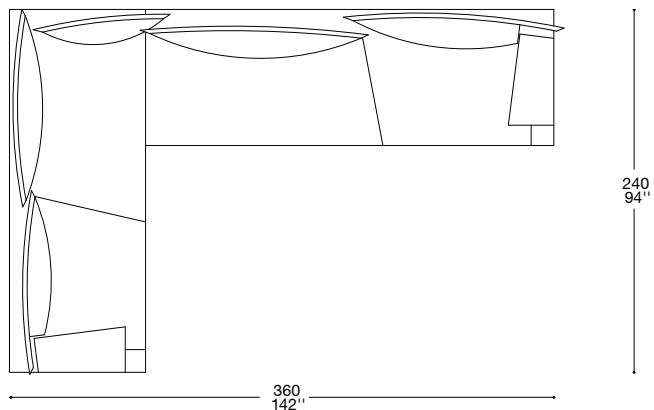

SRO 134

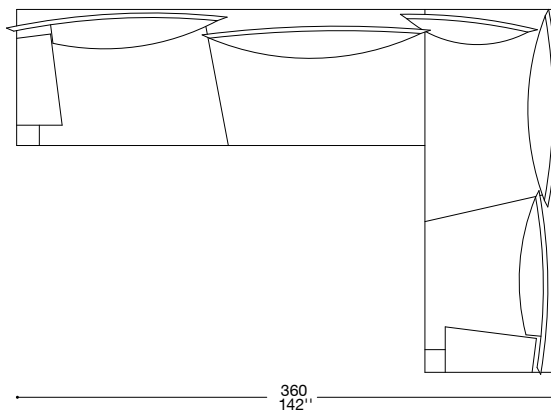

27 ►

SRO 135

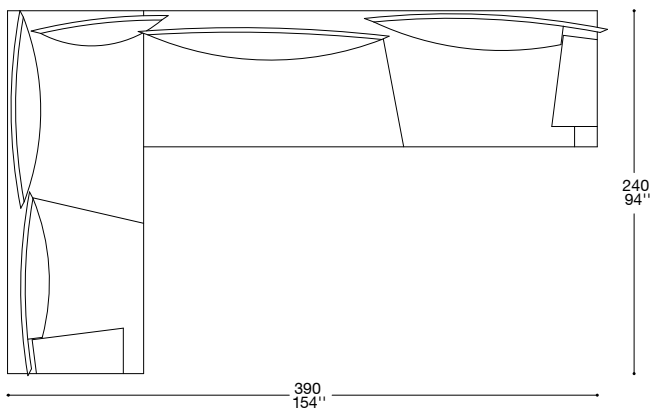

SRO 136

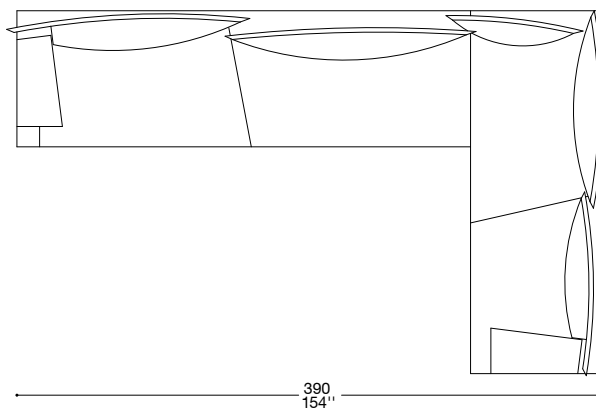

I prodotti della Collezione Outdoor sono stati testati per la collocazione da esterno, l'utilizzo ideale consigliato è per terrazze e verande ed è buona norma proteggere gli articoli da esterno adottando accorgimenti che consentono di migliorarne la durata.

È possibile acquistare l'apposito winter set che consente di proteggere meglio dalle intemperie i prodotti acquistati. Preghiamo accertarsi che tutti i prodotti siano completamente asciutti prima di coprirli per evitare accumuli di umidità o la formazione di macchie di muffa.

*The products in the Outdoor Collection have been tested so that may be used outside, ideally on terraces and verandas. Outdoor furniture should receive the correct care and maintenance to extend the life of the product.*

*Il Loft sells the special winter set which enables you to provide the best protection against bad weather for your purchases. Please ensure that all pieces of furniture are completely dry before covering them to prevent damp patches or the formation of mould stains.*

## SUPER ROY OUTDOOR ANGOLARE

SRO 137

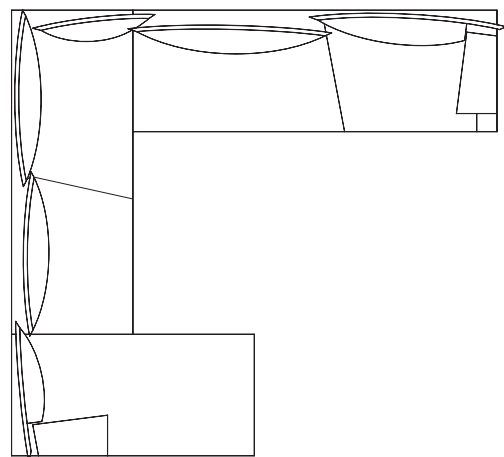

360  
142"

SRO 138

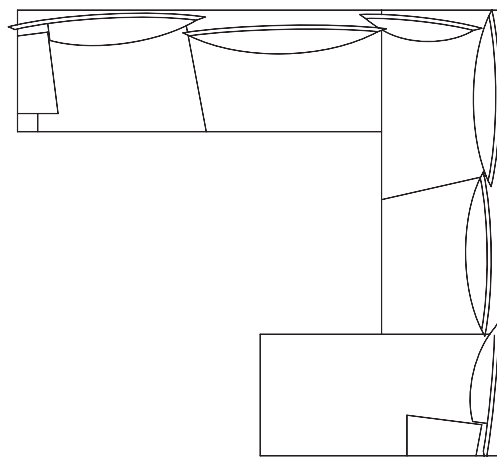

360  
142"

330  
130"

28 ►

SRO 139

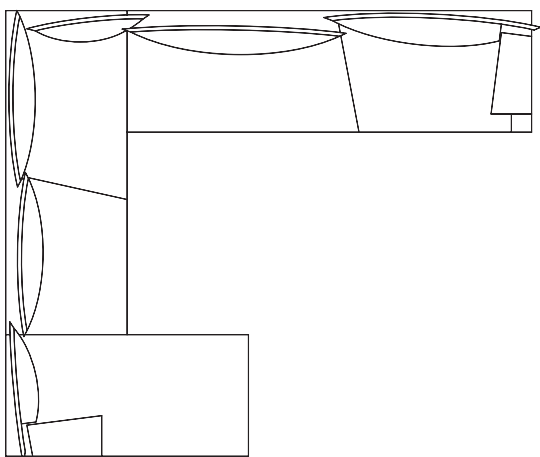

390  
154"

SRO 140

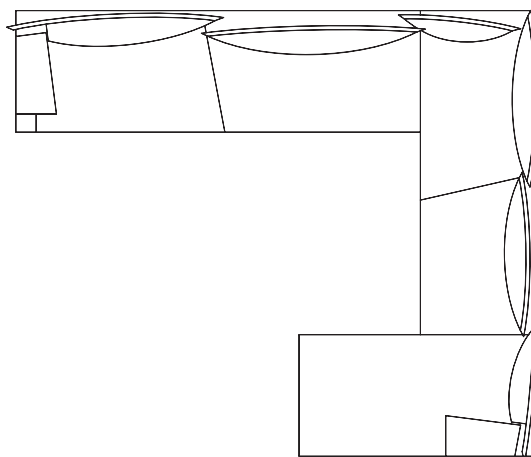

390  
154"

330  
130"

I prodotti della Collezione Outdoor sono stati testati per la collocazione da esterno, l'utilizzo ideale consigliato è per terrazze e verande ed è buona norma proteggere gli articoli da esterno adottando accorgimenti che consentono di migliorarne la durata.

È possibile acquistare l'apposito winter set che consente di proteggere meglio dalle intemperie i prodotti acquistati. Preghiamo accertarsi che tutti i prodotti siano completamente asciutti prima di coprirli per evitare accumuli di umidità o la formazione di macchie di muffa.

*The products in the Outdoor Collection have been tested so that may be used outside, ideally on terraces and verandas. Outdoor furniture should receive the correct care and maintenance to extend the life of the product. Il Loft sells the special winter set which enables you to provide the best protection against bad weather for your purchases. Please ensure that all pieces of furniture are completely dry before covering them to prevent damp patches or the formation of mould stains.*

## SUPER ROY OUTDOOR ESECUZIONE SPECIALE

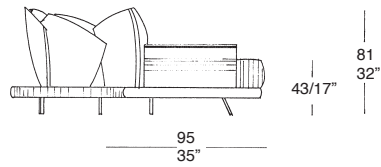

SRO 80

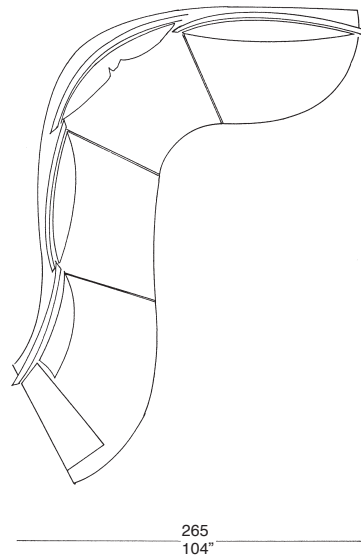

SRO 81



29 ►

SRO 86

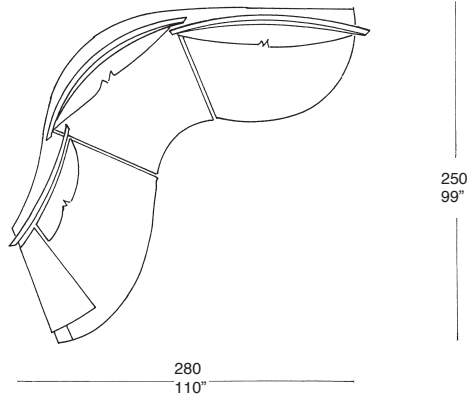

SRO 87

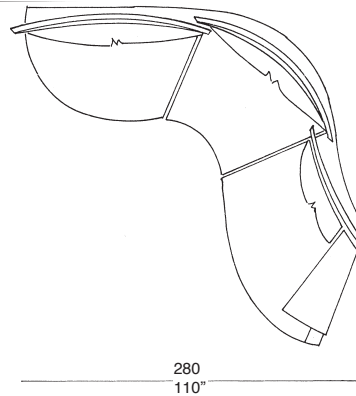

I prodotti della Collezione Outdoor sono stati testati per la collocazione da esterno, l'utilizzo ideale consigliato è per terrazzi e verande ed è buona norma proteggere gli articoli da esterno adottando accorgimenti che consentono di migliorarne la durata.

È possibile acquistare l'apposito winter set che consente di proteggere meglio dalle intemperie i prodotti acquistati. Preghiamo accertarsi che tutti i prodotti siano completamente asciutti prima di coprirli per evitare accumuli di umidità o la formazione di macchie di muffa.

*The products in the Outdoor Collection have been tested so that may be used outside, ideally on terraces and verandas. Outdoor furniture should receive the correct care and maintenance to extend the life of the product. Il Loft sells the special winter set which enables you to provide the best protection against bad weather for your purchases. Please ensure that all pieces of furniture are completely dry before covering them to prevent damp patches or the formation of mould stains.*

## SUPER ROY OUTDOOR ESECUZIONE SPECIALE C.L.

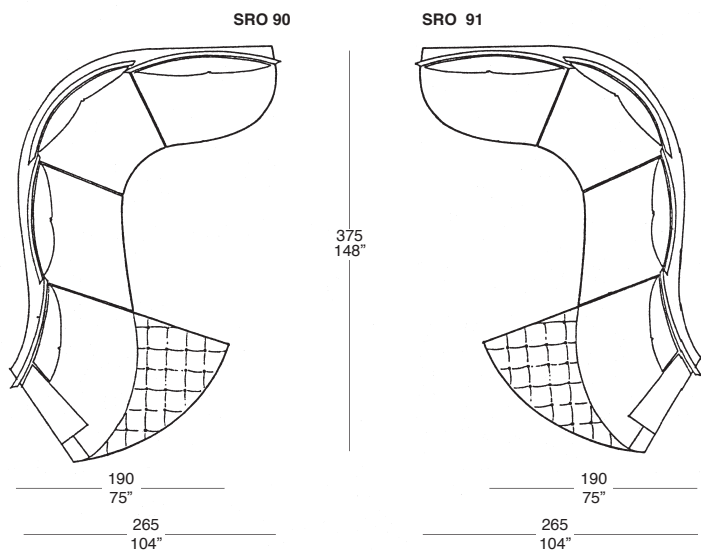

30 ►

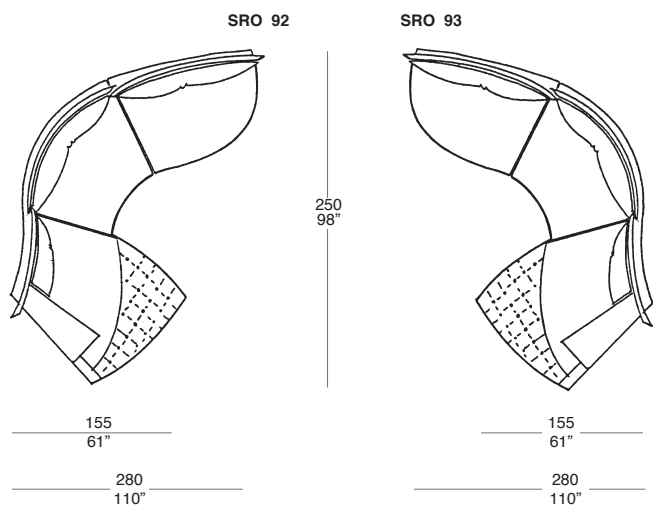

I prodotti della Collezione Outdoor sono stati testati per la collocazione da esterno, l'utilizzo ideale consigliato è per terrazzi e verande ed è buona norma proteggere gli articoli da esterno adottando accorgimenti che consentono di migliorarne la durata.

È possibile acquistare l'apposito winter set che consente di proteggere meglio dalle intemperie i prodotti acquistati. Preghiamo accertarsi che tutti i prodotti siano completamente asciutti prima di coprirli per evitare accumuli di umidità o la formazione di macchie di muffa

*The products in the Outdoor Collection have been tested so that may be used outside, ideally on terraces and verandas. Outdoor furniture should receive the correct care and maintenance to extend the life of the product. Il Loft sells the special winter set which enables you to provide the best protection against bad weather for your purchases. Please ensure that all pieces of furniture are completely dry before covering them to prevent damp patches or the formation of mould stains.*

## SUPER ROY OUTDOOR ESECUZIONE SPECIALE

SRO 103

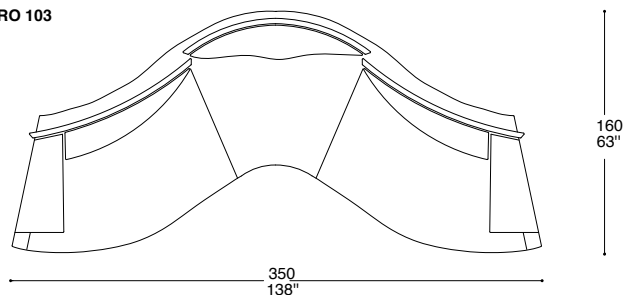

SRO 104

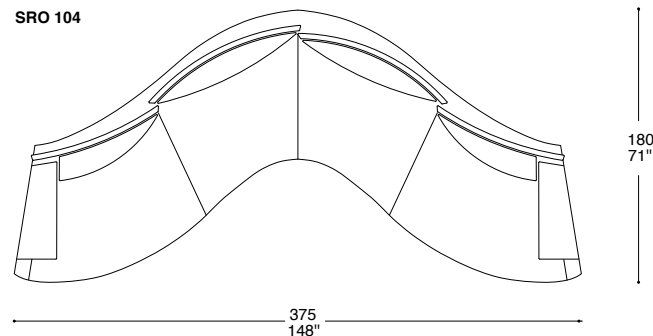

31 ►

## SUPER ROY OUTDOOR ESECUZIONE SPECIALE SEMICIRCOLARE

SRO 105

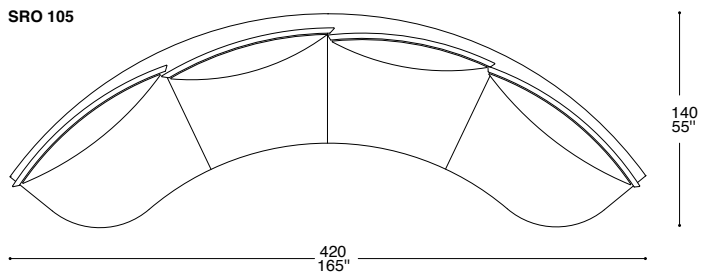

SRO 106

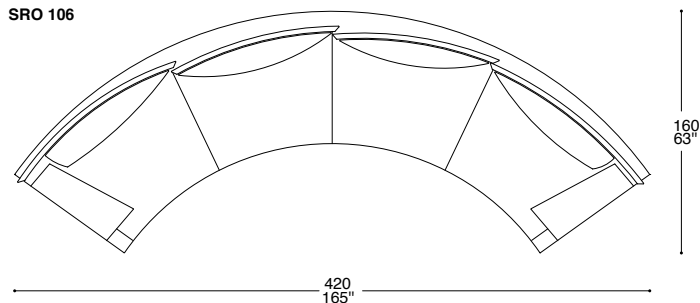

I prodotti della Collezione Outdoor sono stati testati per la collocazione da esterno, l'utilizzo ideale consigliato è per terrazzi e verande ed è buona norma proteggere gli articoli da esterno adottando accorgimenti che consentono di migliorarne la durata.

È possibile acquistare l'apposito winter set che consente di proteggere meglio dalle intemperie i prodotti acquistati. Preghiamo accertarsi che tutti i prodotti siano completamente asciutti prima di coprirli per evitare accumuli di umidità o la formazione di macchie di muffa

*The products in the Outdoor Collection have been tested so that may be used outside, ideally on terraces and verandas. Outdoor furniture should receive the correct care and maintenance to extend the life of the product. Il Loft sells the special winter set which enables you to provide the best protection against bad weather for your purchases. Please ensure that all pieces of furniture are completely dry before covering them to prevent damp patches or the formation of mould stains.*

## FLOWER OUTDOOR POLTRONA

FLO 10

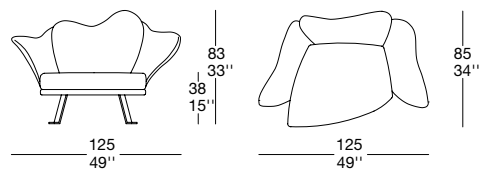

32 ►

## JADA OUTDOOR POLTRONCINA

JDO 01

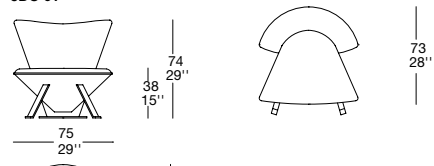

I prodotti della Collezione Outdoor sono stati testati per la collocazione da esterno, l'utilizzo ideale consigliato è per terrazzi e verande ed è buona norma proteggere gli articoli da esterno adottando accorgimenti che consentono di migliorarne la durata.

È possibile acquistare l'apposito winter set che consente di proteggere meglio dalle intemperie i prodotti acquistati. Preghiamo accertarsi che tutti i prodotti siano completamente asciutti prima di coprirli per evitare accumuli di umidità o la formazione di macchie di muffa

*The products in the Outdoor Collection have been tested so that may be used outside, ideally on terraces and verandas. Outdoor furniture should receive the correct care and maintenance to extend the life of the product. Il Loft sells the special winter set which enables you to provide the best protection against bad weather for your purchases. Please ensure that all pieces of furniture are completely dry before covering them to prevent damp patches or the formation of mould stains.*



## GIORGIO OUTDOOR POLTRONA

GIO 02

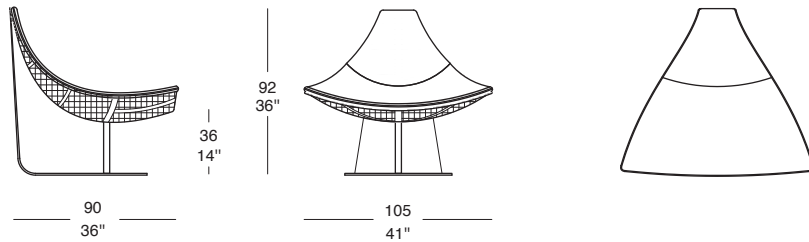

GIO 03

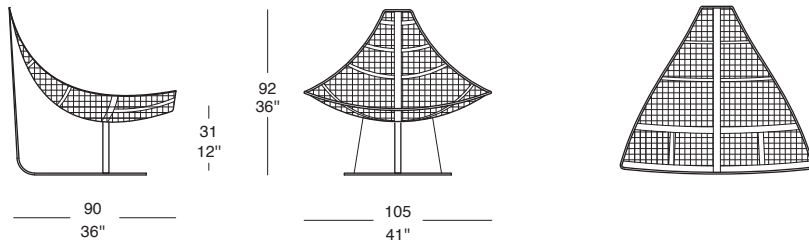

GIO 04 CUSHION

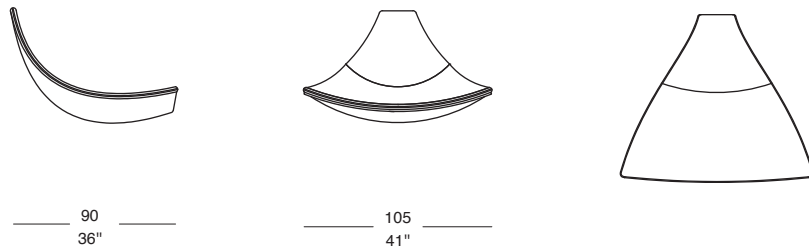

I prodotti della Collezione Outdoor sono stati testati per la collocazione da esterno, l'utilizzo ideale consigliato è per terrazzi e verande ed è buona norma proteggere gli articoli da esterno adottando accorgimenti che consentono di migliorarne la durata.

È possibile acquistare l'apposito winter set che consente di proteggere meglio dalle intemperie i prodotti acquistati. Preghiamo accertarsi che tutti i prodotti siano completamente asciutti prima di coprirli per evitare accumuli di umidità o la formazione di macchie di muffa

*The products in the Outdoor Collection have been tested so that may be used outside, ideally on terraces and verandas. Outdoor furniture should receive the correct care and maintenance to extend the life of the product. Il Loft sells the special winter set which enables you to provide the best protection against bad weather for your purchases. Please ensure that all pieces of furniture are completely dry before covering them to prevent damp patches or the formation of mould stains.*

## HERMAN OUTDOOR SEDIA

HMO 07

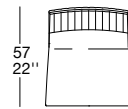
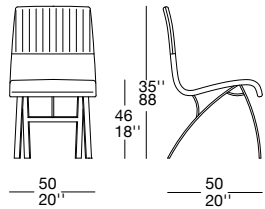

I prodotti della Collezione Outdoor sono stati testati per la collocazione da esterno, l'utilizzo ideale consigliato è per terrazzi e verande ed è buona norma proteggere gli articoli da esterno adottando accorgimenti che consentono di migliorarne la durata.

È possibile acquistare l'apposito winter set che consente di proteggere meglio dalle intemperie i prodotti acquistati. Preghiamo accertarsi che tutti i prodotti siano completamente asciutti prima di coprirli per evitare accumuli di umidità o la formazione di macchie di muffa

*The products in the Outdoor Collection have been tested so that may be used outside, ideally on terraces and verandas. Outdoor furniture should receive the correct care and maintenance to extend the life of the product.*

*Il Loft sells the special winter set which enables you to provide the best protection against bad weather for your purchases. Please ensure that all pieces of furniture are completely dry before covering them to prevent damp patches or the formation of mould stains.*

## SOLLER OUTDOOR SEDIA

### STRUTTURA SEDIA CHAIR FRAME

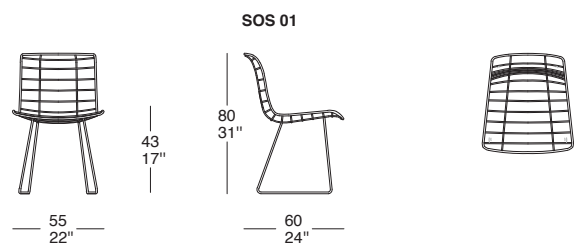

### CUSCINO SEDUTA SEDIA CHAIR SEAT CUSHION

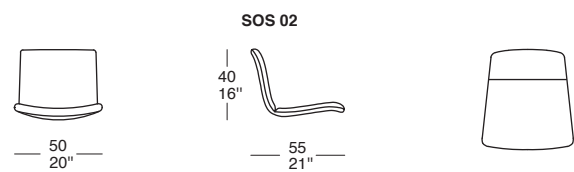

35 ►

### SEDIA CON CUSCINO SEDUTA CHAIR WITH SEAT CUSHION

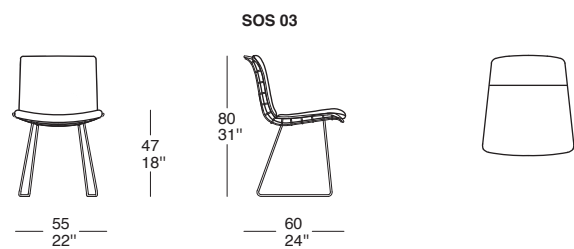

## ZEROMOON OUTDOOR SEDIA

**ZEROMOON IMBOTTITA OUTDOOR  
ZER001**

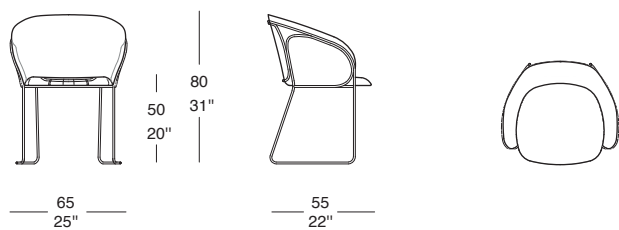

**ZEROMOON COVER OUTDOOR  
ZER002**

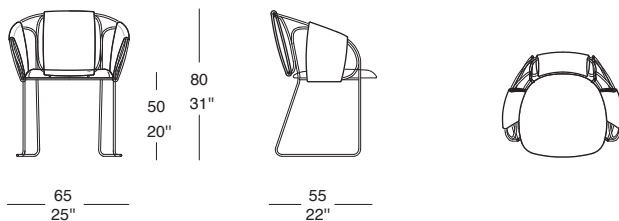

## GIORGIO OUTDOOR TAVOLO

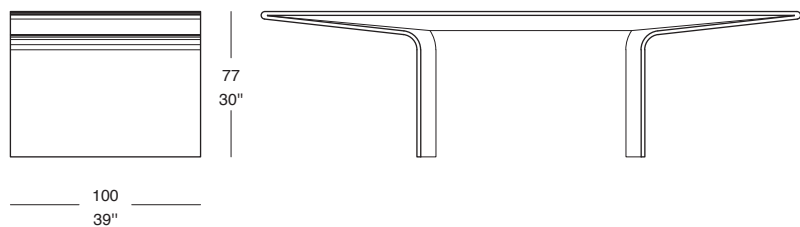

GI00 10

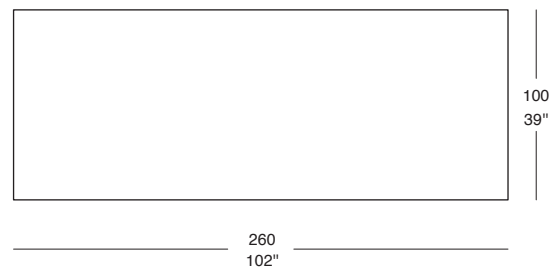

GI00 11

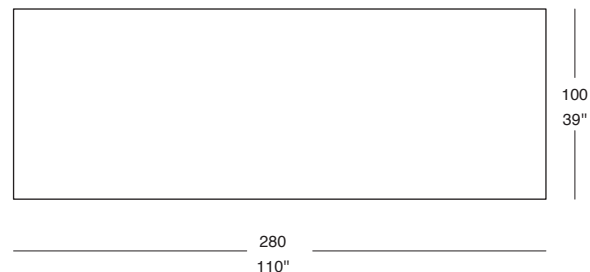

GI00 12

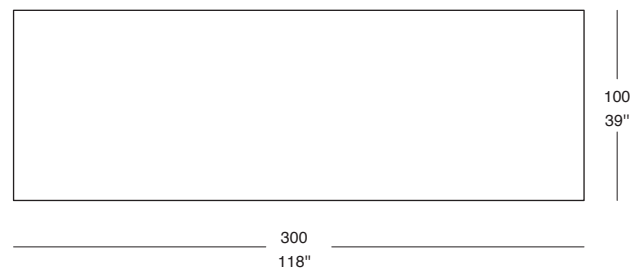

I prodotti della Collezione Outdoor sono stati testati per la collocazione da esterno, l'utilizzo ideale consigliato è per terrazzi e verande ed è buona norma proteggere gli articoli da esterno adottando accorgimenti che consentono di migliorarne la durata. È possibile acquistare l'apposito winter set che consente di proteggere meglio dalle intemperie i prodotti acquistati. Preghiamo accertarsi che tutti i prodotti siano completamente asciutti prima di coprirli per evitare accumuli di umidità o la formazione di macchie di muffa.

*The products in the Outdoor Collection have been tested so that may be used outside, ideally on terraces and verandas. Outdoor furniture should receive the correct care and maintenance to extend the life of the product.*

*Il Loft sells the special winter set which enables you to provide the best protection against bad weather for your purchases. Please ensure that all pieces of furniture are completely dry before covering them to prevent damp patches or the formation of mould stains.*

## LEO VETRO MARMO OUTDOOR TAVOLO



LEO 70

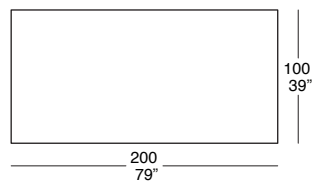

LEO 71

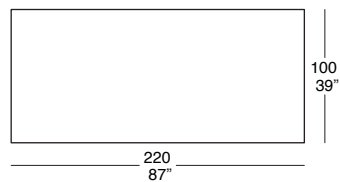

LEO 72

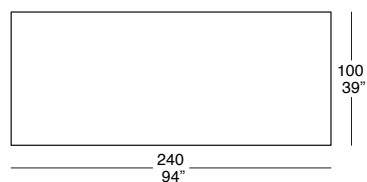

LEO 73

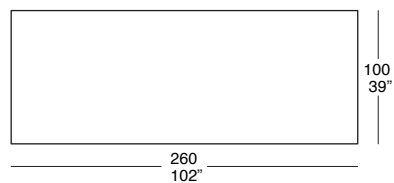

I prodotti della Collezione Outdoor sono stati testati per la collocazione da esterno, l'utilizzo ideale consigliato è per terrazze e verande ed è buona norma proteggere gli articoli da esterno adottando accorgimenti che consentono di migliorarne la durata.

È possibile acquistare l'apposito winter set che consente di proteggere meglio dalle intemperie i prodotti acquistati. Preghiamo accertarsi che tutti i prodotti siano completamente asciutti prima di coprirli per evitare accumuli di umidità o la formazione di macchie di muffa.

*The products in the Outdoor Collection have been tested so that may be used outside, ideally on terraces and verandas. Outdoor furniture should receive the correct care and maintenance to extend the life of the product. Il Loft sells the special winter set which enables you to provide the best protection against bad weather for your purchases. Please ensure that all pieces of furniture are completely dry before covering them to prevent damp patches or the formation of mould stains.*

## LEO VETRO MARMO OUTDOOR TAVOLO

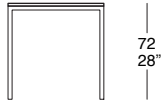

LEO 74

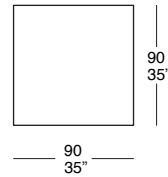

LEO 75

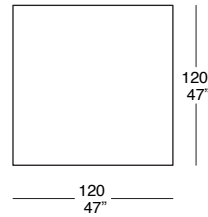

LEO 76

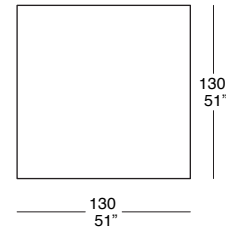

LEO 77

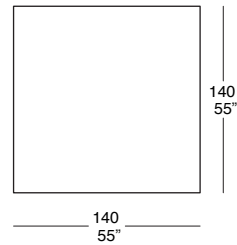

LEO 78

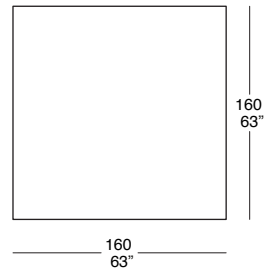

I prodotti della Collezione Outdoor sono stati testati per la collocazione da esterno, l'utilizzo ideale consigliato è per terrazzi e verande ed è buona norma proteggere gli articoli da esterno adottando accorgimenti che consentono di migliorarne la durata.

È possibile acquistare l'apposito winter set che consente di proteggere meglio dalle intemperie i prodotti acquistati. Preghiamo accertarsi che tutti i prodotti siano completamente asciutti prima di coprirli per evitare accumuli di umidità o la formazione di macchie di muffa.

*The products in the Outdoor Collection have been tested so that may be used outside, ideally on terraces and verandas. Outdoor furniture should receive the correct care and maintenance to extend the life of the product. Il Loft sells the special winter set which enables you to provide the best protection against bad weather for your purchases. Please ensure that all pieces of furniture are completely dry before covering them to prevent damp patches or the formation of mould stains.*

# SOLLER OUTDOOR TAVOLO

BASE TAVOLO  
DINING TABLE BASE

SOT01

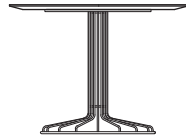
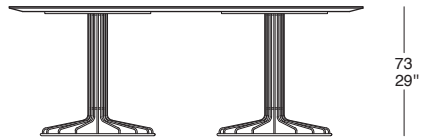
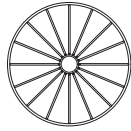
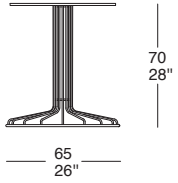

SOT 02

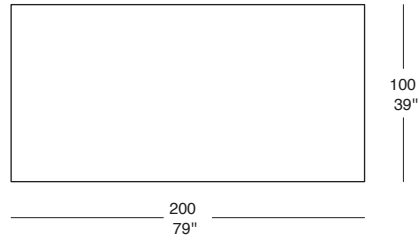

SOT 03

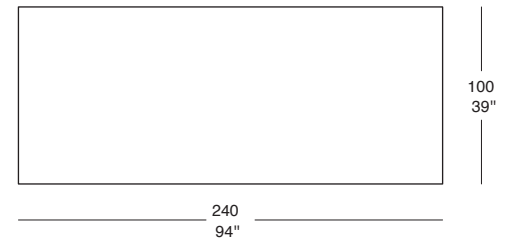

SOT 04

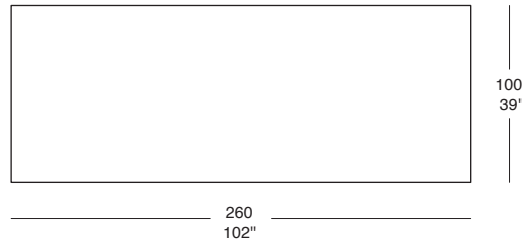

SOT 05

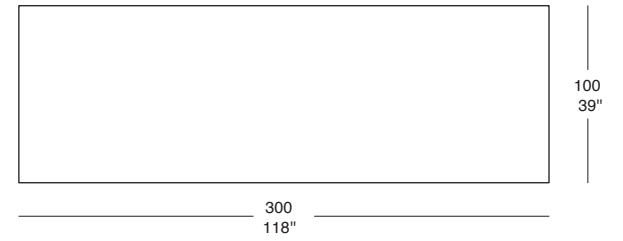



SOLLER OUTDOOR TAVOLO

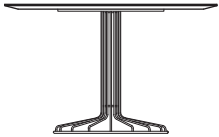

73  
29"

SOT 06

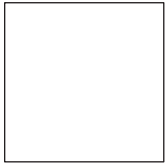

90  
35"

90  
35"

SOT 07

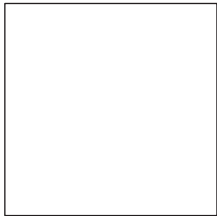

120  
47"

120  
47"

SOT 08

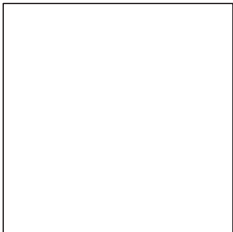

130  
51"

130  
51"

SOT 09

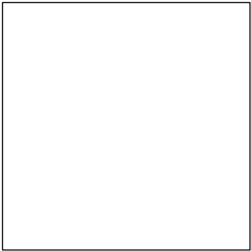

140  
55"

140  
55"

SOT 10

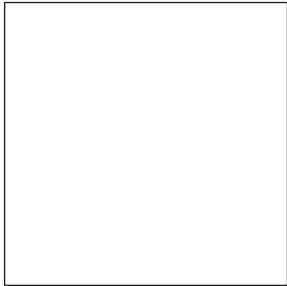

160  
63"

160  
63"

**SOLLER OUTDOOR TAVOLO**

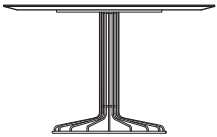

73  
29"

**SOT 11**

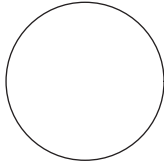

90  
35"

**SOT 12**

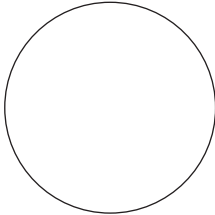

120  
47"

**SOT 13**

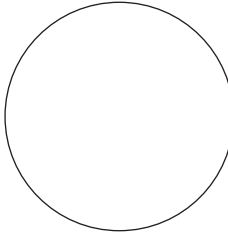

130  
51"

**SOT 14**

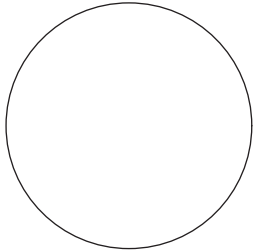

140  
55"

**SOT 15**

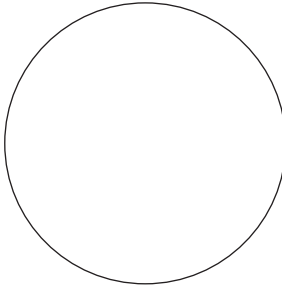

160  
63"

## SQUARE OUTDOOR TAVOLO

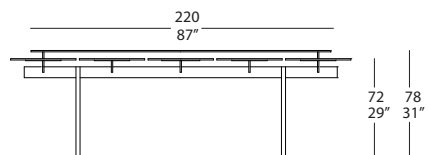

SQU 02

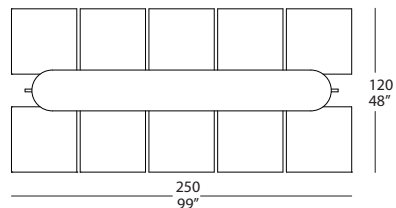

SQU 01

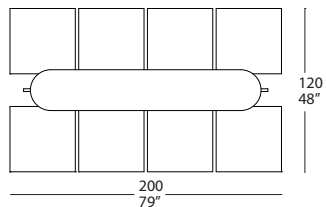

43 ►

I prodotti della Collezione Outdoor sono stati testati per la collocazione da esterno, l'utilizzo ideale consigliato è per terrazzi e verande ed è buona norma proteggere gli articoli da esterno adottando accorgimenti che consentono di migliorarne la durata.

È possibile acquistare l'apposito winter set che consente di proteggere meglio dalle intemperie i prodotti acquistati. Preghiamo accertarsi che tutti i prodotti siano completamente asciutti prima di coprirli per evitare accumuli di umidità o la formazione di macchie di muffa

*The products in the Outdoor Collection have been tested so that may be used outside, ideally on terraces and verandas. Outdoor furniture should receive the correct care and maintenance to extend the life of the product. Il Loft sells the special winter set which enables you to provide the best protection against bad weather for your purchases. Please ensure that all pieces of furniture are completely dry before covering them to prevent damp patches or the formation of mould stains.*