

ACCADEMIA UFFICIO

AC 80

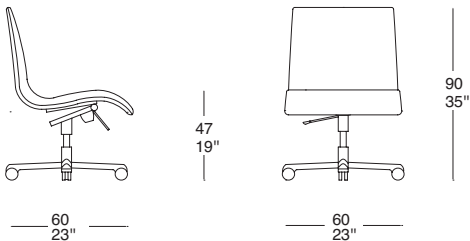

AC 81

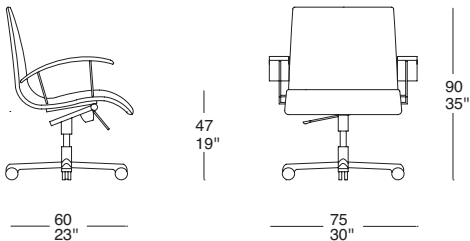

1 ▶

AC 82

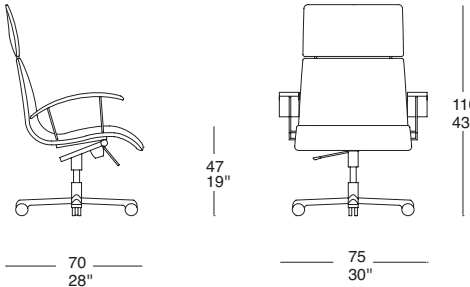

## ADAM POLTRONCINA

AD 03

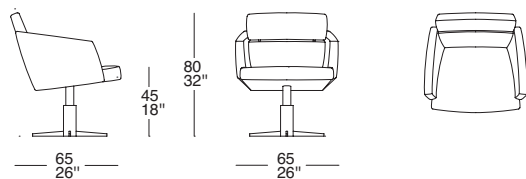

## ADAM UFFICIO

AD 02

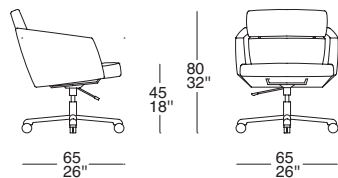

2 ▶

AD 04

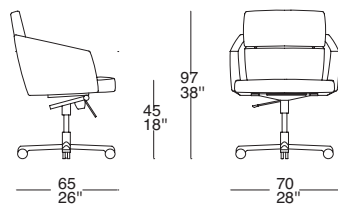

AD 05

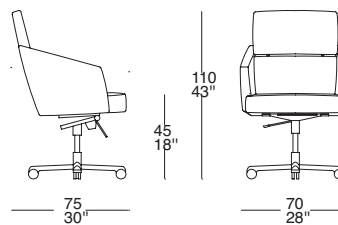

COLLEGE

CL 03

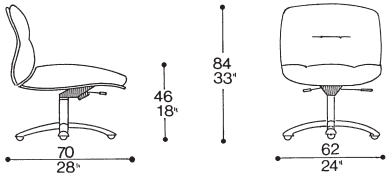

CL 02

3 ▶

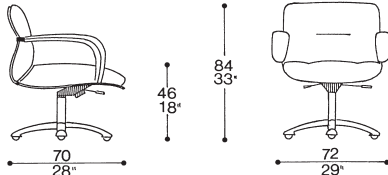

CL 01

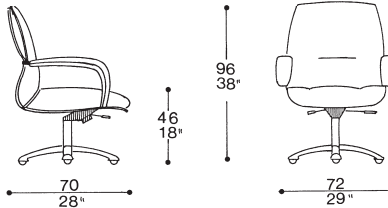

## HERMAN UFFICIO

HM 16  
HM 18

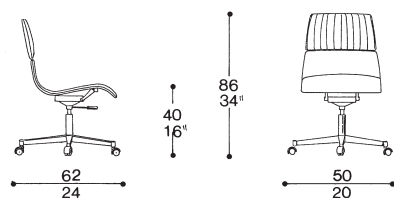

HM 19  
HM 21

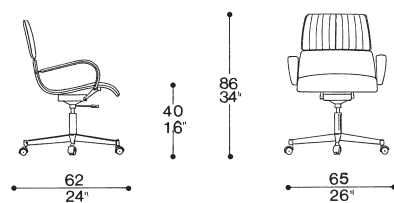

4 ▶

## HERMAN CAPITONNÉ UFFICIO

HM 35

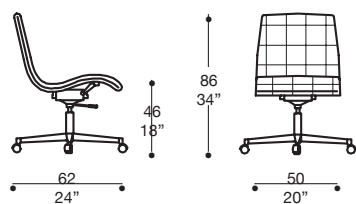

HM 36

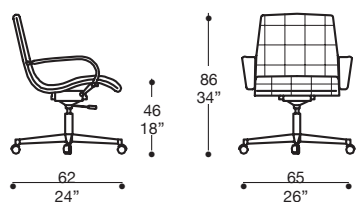

## HERMAN DIREZIONALE

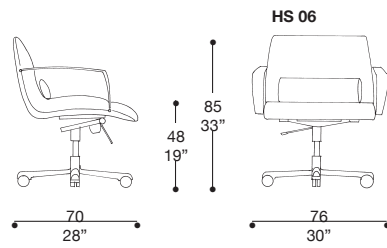
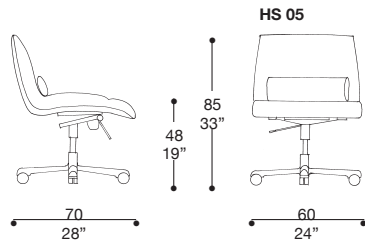

5 ▶

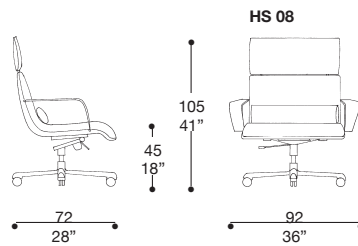
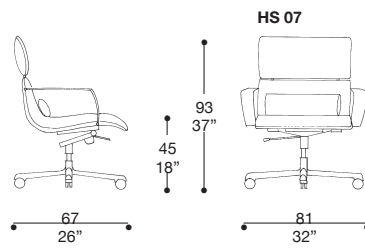

HERMAN STUDIO

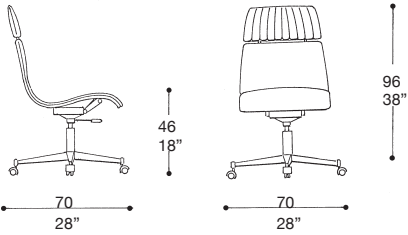

HS 01

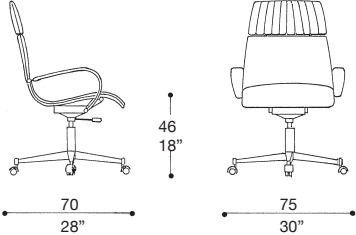

HS 02

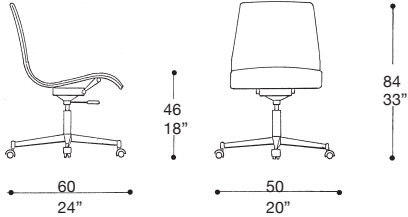

HS 03

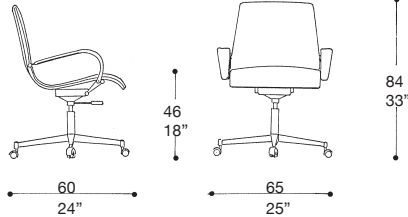

HS 04

## LUIS UFFICIO

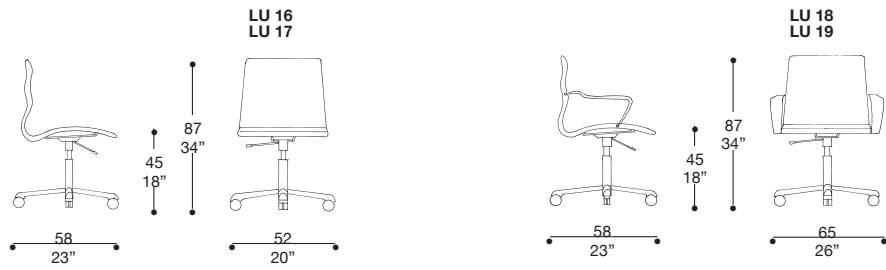

## OLYMPIC STUDIO

7 ▶

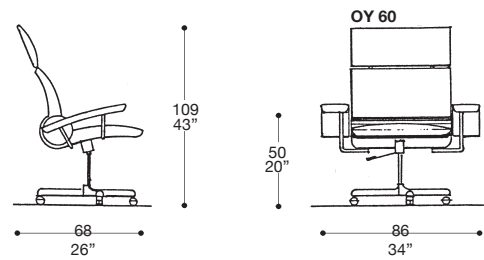
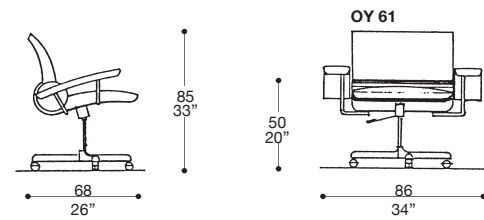
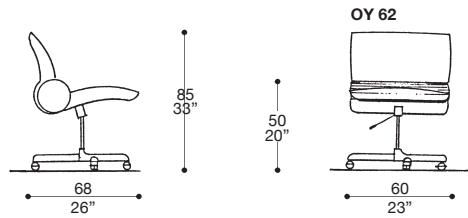

# PARK

PK 90

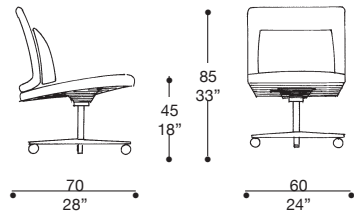

PK 91

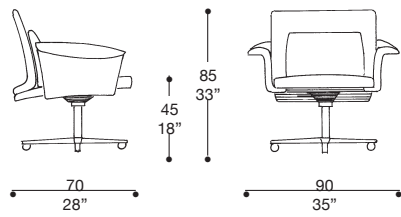

8 ▶

PK 92

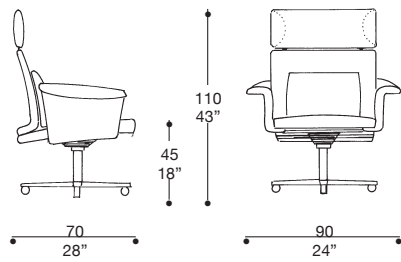



# ACCADEMIA

AC 70

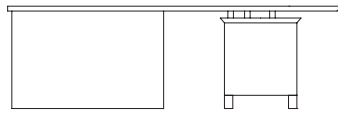

58  
23"

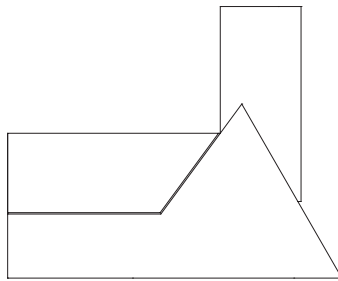

240  
94"

74  
29"

AC 71

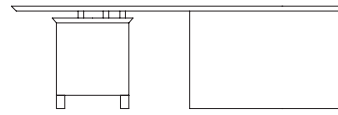

58  
23"

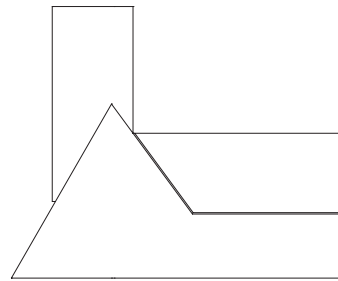

240  
94"

125  
49"

195  
77"

125  
49"

9 ▶

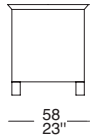

58  
23"

65  
26"

AC 72

SX

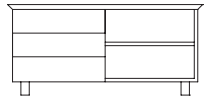

140  
55"

AC 73

DX

65  
26"

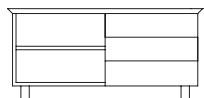

140  
55"

AC 74

60  
24"

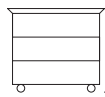

70  
27"

# GEOX SCRIVANIA

GE 50

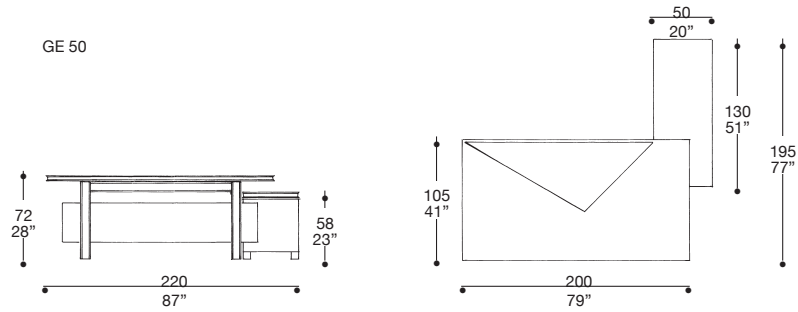

GE 51

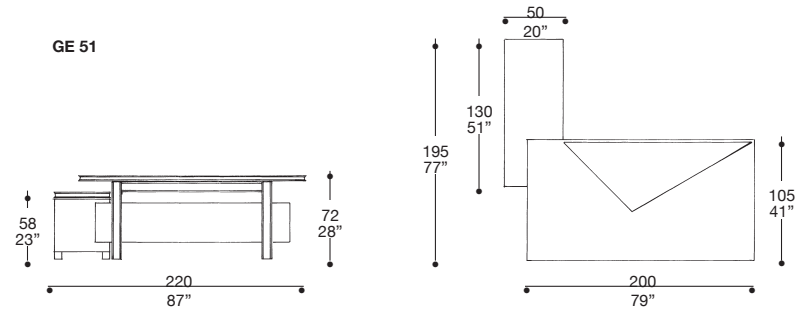

GE 52

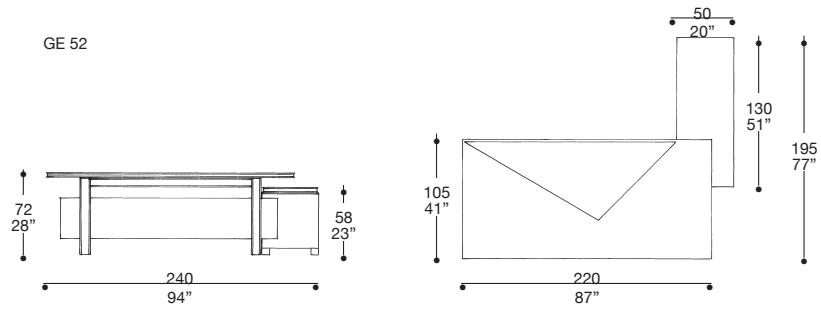

GE 53

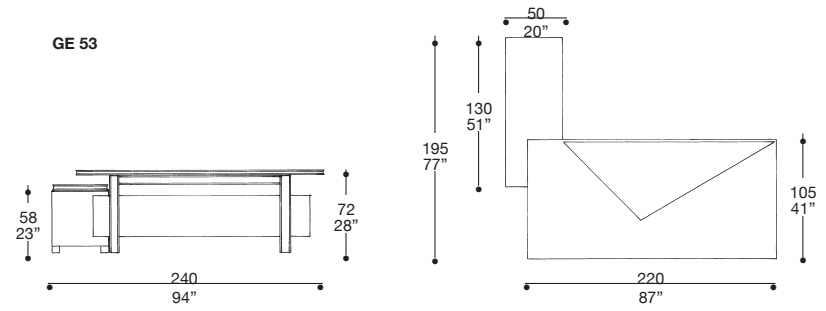

GE 54

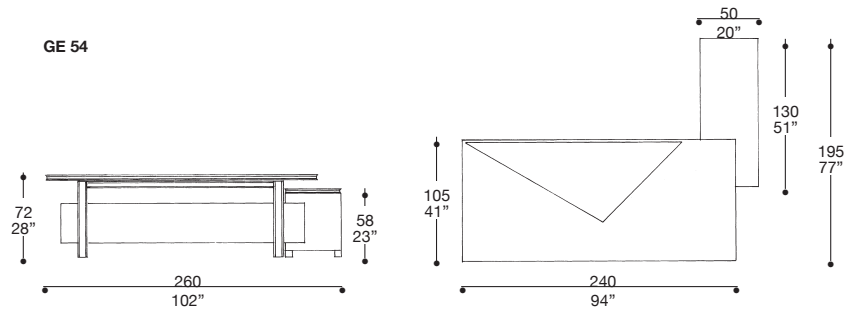

GE 55

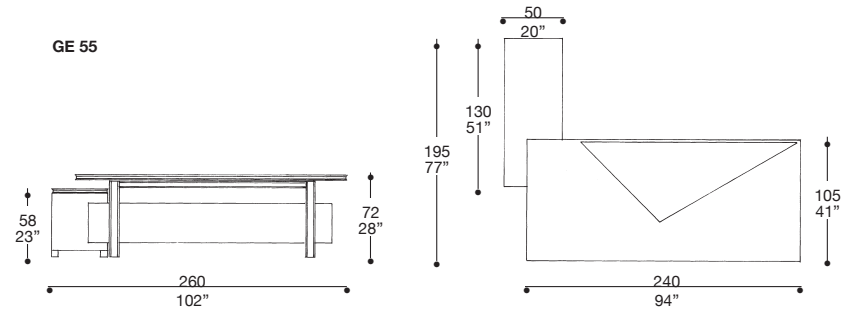

## GEOX SCRIVANIA

**GE 56**

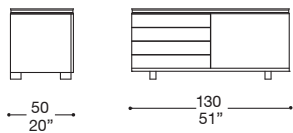

**GE 57**

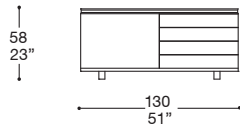

**GE 58**

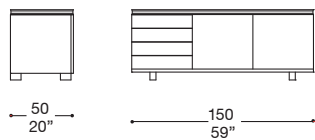

**GE 59**

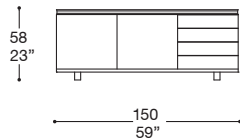

11 ►

**GE 60**

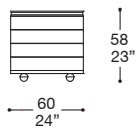

## HAKI

HAK 01

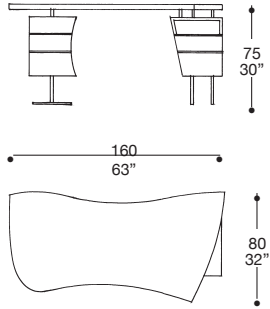

HAK 02

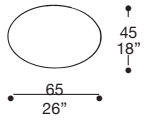

12 ►

## MIRAK

MI 50

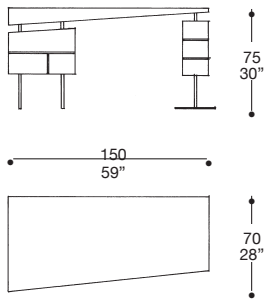

# JOHN SCRIVANIA LINEARE

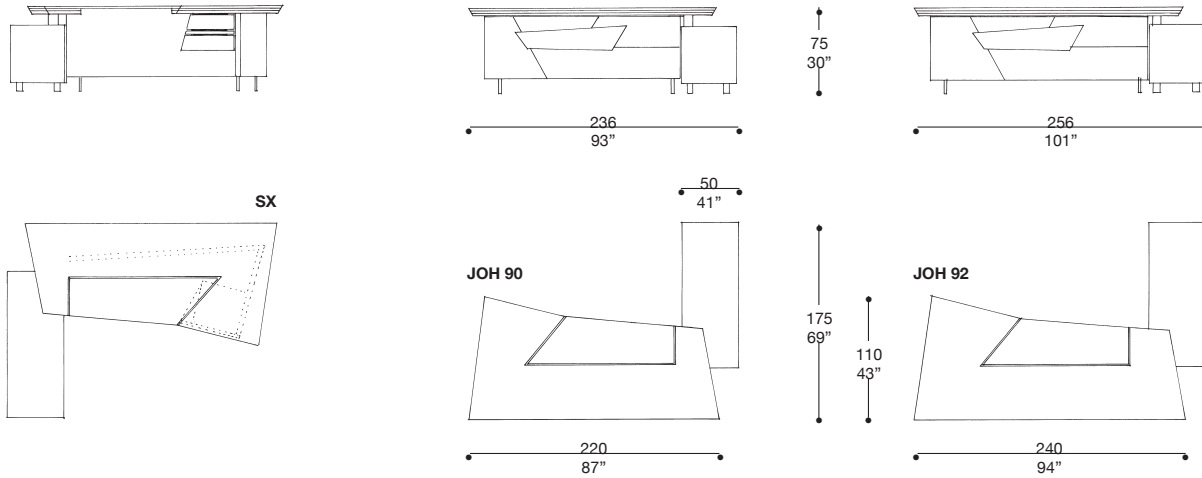

13 ►

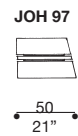
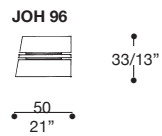
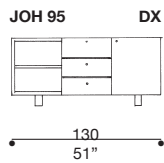
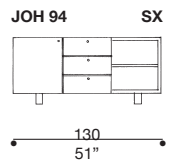
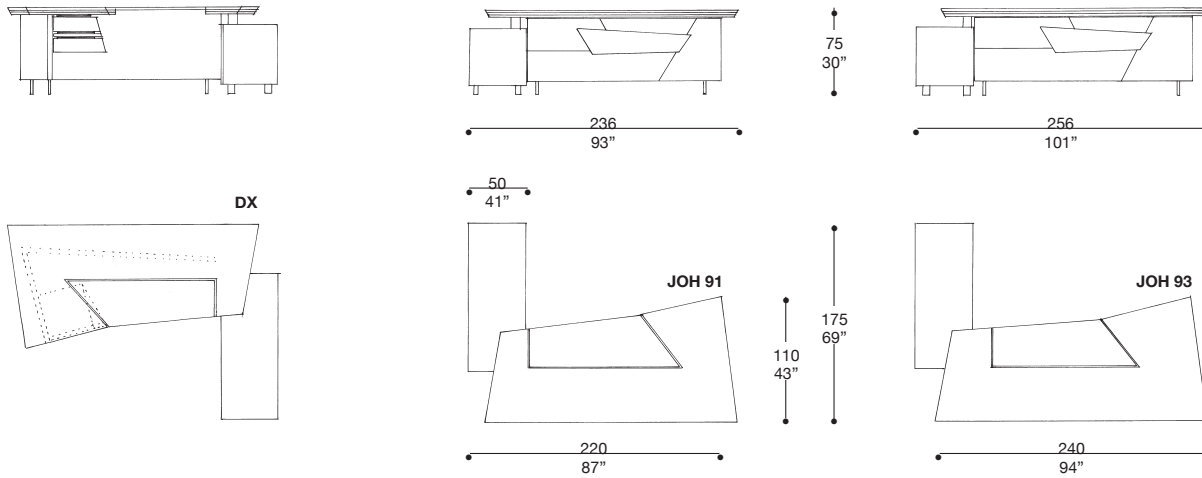

# JOHN SCRIVANIA SAGOMATA

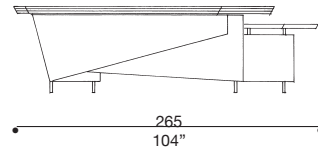
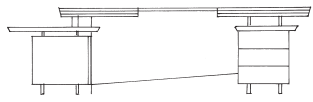

75  
30"

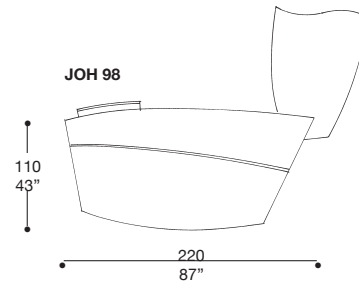
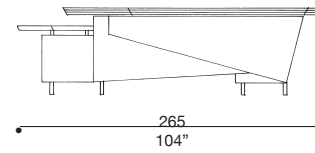

195  
77"

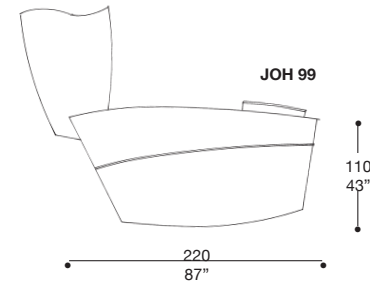

14 ►

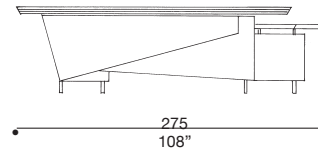
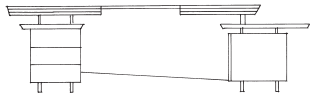

75  
30"

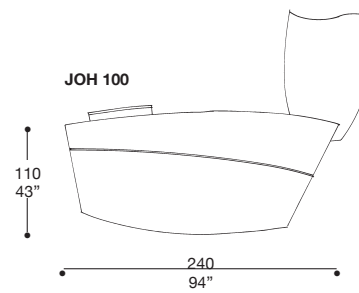
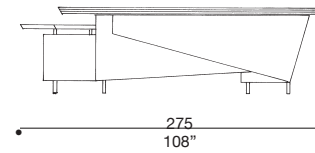

195  
77"

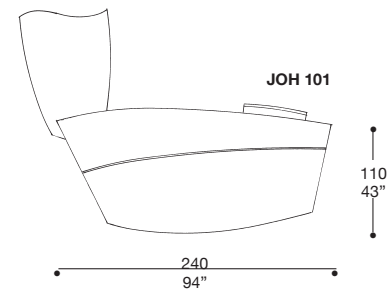

# JOHN SCRIVANIA SAGOMATA

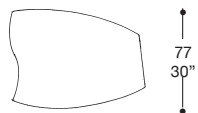

**JOH 102 SX**

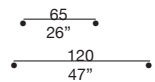
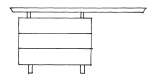

**JOH 103 SX**

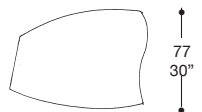
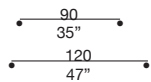
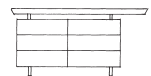

15 ▶

**JOH 105 DX**

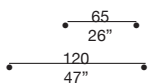
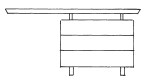

**JOH 106 DX**

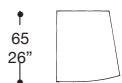
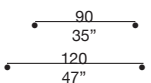
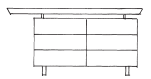

**JOH 104**



**JOH 107**



OLYMPIC SCRIVANIA

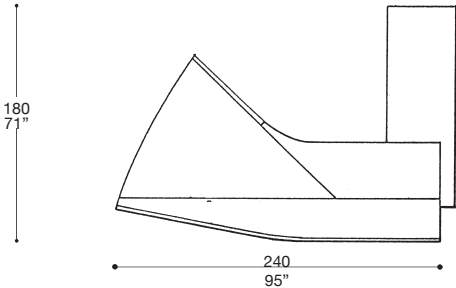
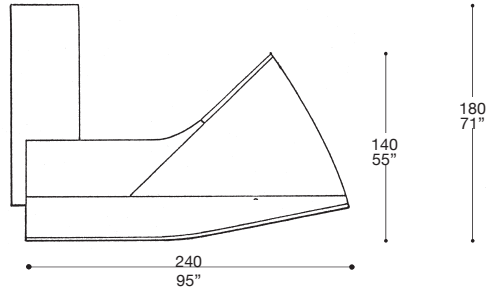
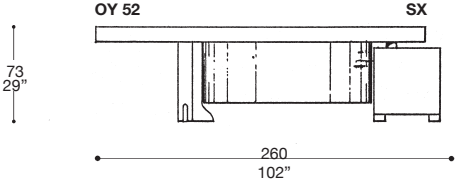
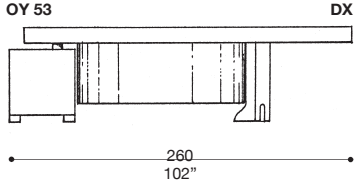

16 ▶

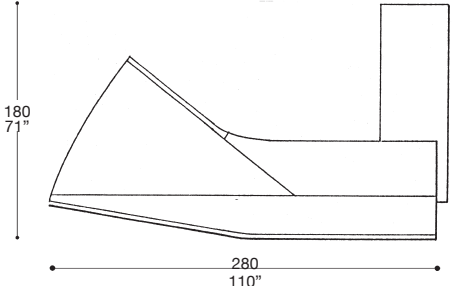
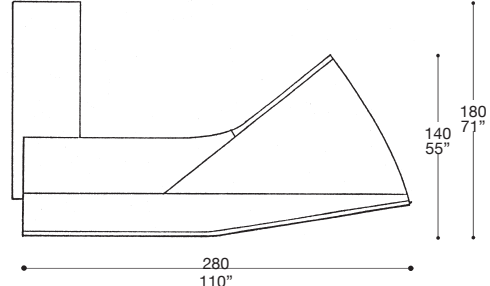
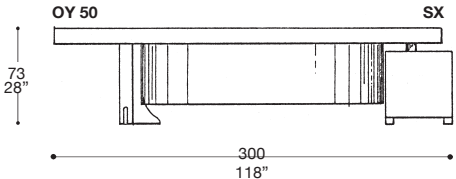
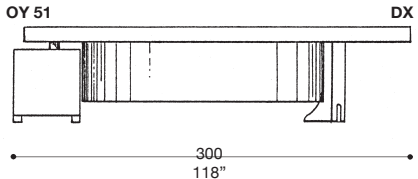



# OLYMPIC SCRIVANIA

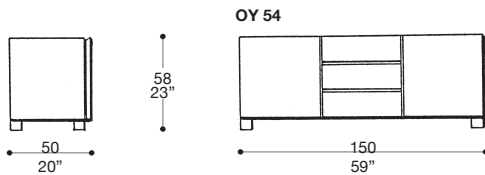

OY 54

17 ▶

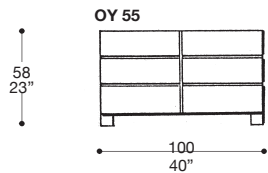

OY 55

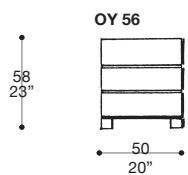

OY 56

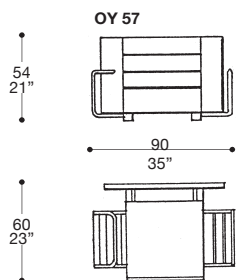

OY 57

# RIGA SCRIVANIA

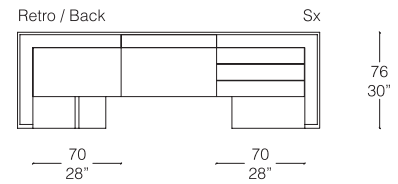
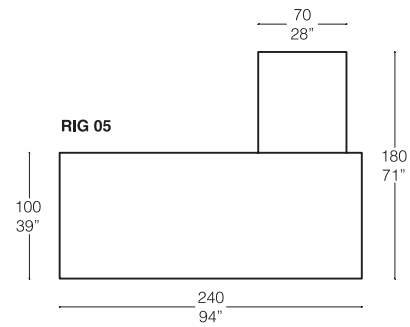
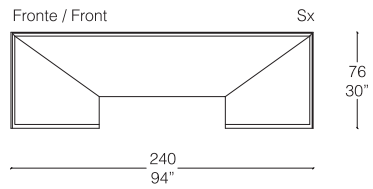

18 ▶

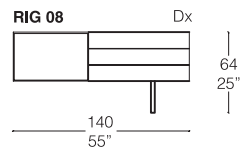
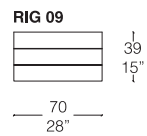
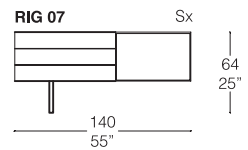
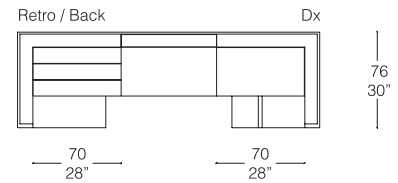
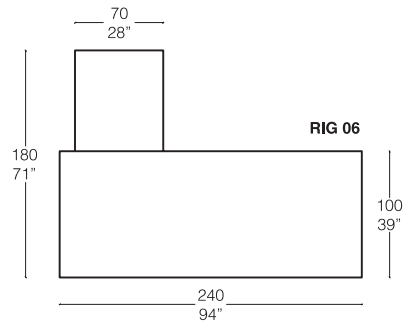
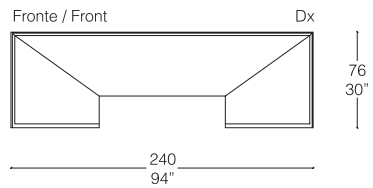

# RIGA TAVOLO

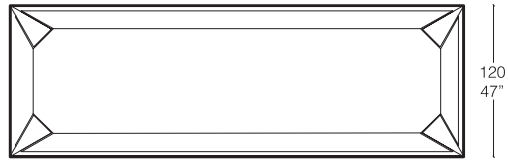
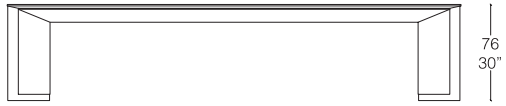

**RIG 01**

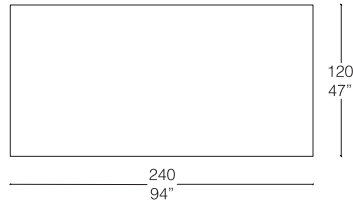

**RIG 02**

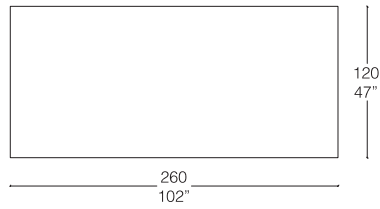

**RIG 03**

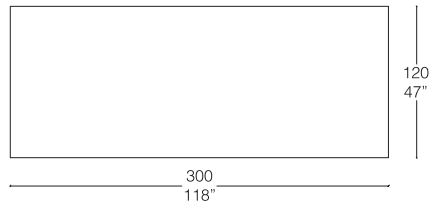

**RIG 04**

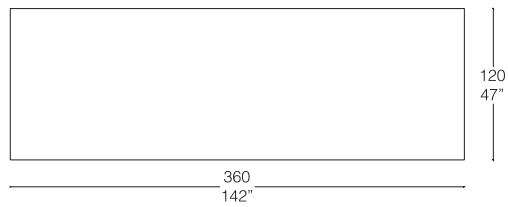

# RUTHY SCRIVANIA CURVA

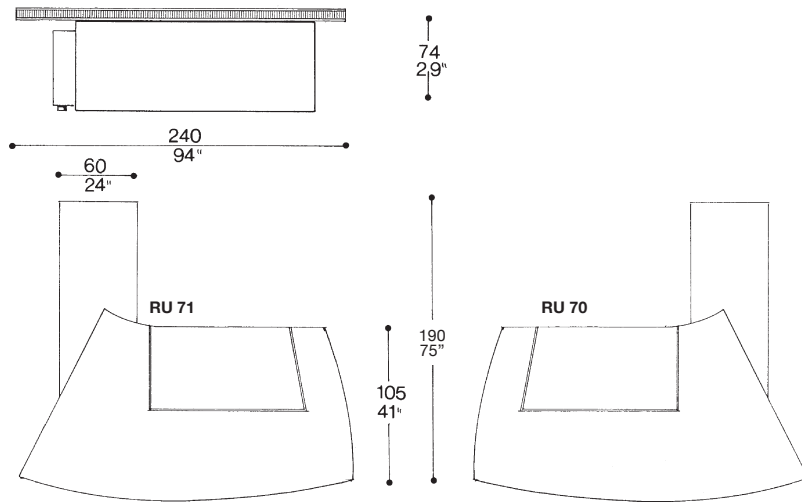

20 ▶

RU 72

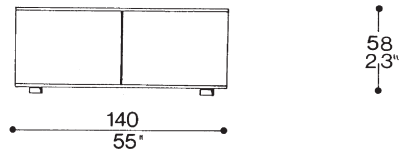

RU 73

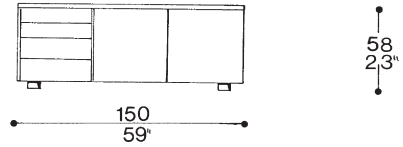

RU 74

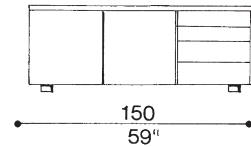

RU 75



# RUTHY SCRIVANIA LINEARE

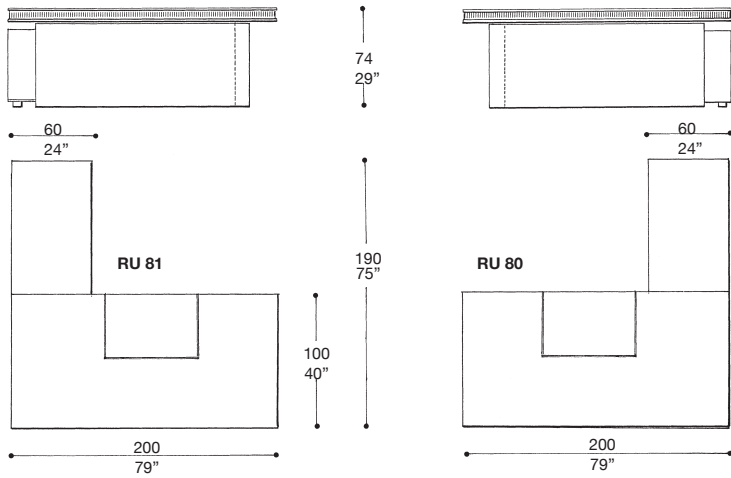

21 ▶

